

Specifications

备注 (Remark)

1. 材料 (MATERIAL)

胶芯: PA6T+30%G.F UL94V-0, 颜色: 黑色.

Housing: PA6T+30%G.F UL94V-0, Color: Black

四方针: 黄铜, 镍底30u"MIN, 表面镀金0.8u"MIN

Contact: Brass, 0.8u"MIN GOLD PLATING OVER ALL
30u" MIN NICKEL UNDERPLATING OVER ALL

2. 特性 (characteristics):

额定电流: 1 AMP

Rating Current: 1 AMP.

接触阻抗: 20 mΩ MAX.

Contact Resistance: 20 mΩ MAX.

绝缘阻抗: 1000 MΩ MIN.

Insulating Resistance: 1000 MΩ MIN.

耐电压: AC 500V/分钟.

Withstanding Voltage: AC 500V/Minute.

温度范围: -40° C to +105° C

Temperture Range: -40° C to +105° C

Ordering Information

P4XX-12 XX XX X S XXX X 1

HEIGHT OF HOUSING	NO. OF PINS PER ROW	Contact Full of Gold	Plating Serial-gold	INSULATOR MATERIAL	LENGTH OF TERMINAL	PACKING
17: 1.7mm 25: 2.54mm	2-50P	A0=0.8u" A1=1u" A2=1.5u" A3=2u" A4=3u" A5=5u" A6=10u" A7=15u" A8=20u" A9=30u"	B0=0.8U" B1=1U" B2=1.5U" B3=2U" B4=3U" B5=5U" B6=10U" B7=15U" B8=20U" B9=30U"	B: PA6T C: PA9T D: LCP	A: PE Bag C: Tube D: Tube+CAP E: Tray	
		S1=Ordinary Tin Plated S2=Matte Tin Plated S3=Tin-plated High-temperature				

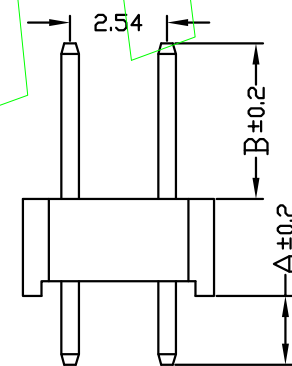
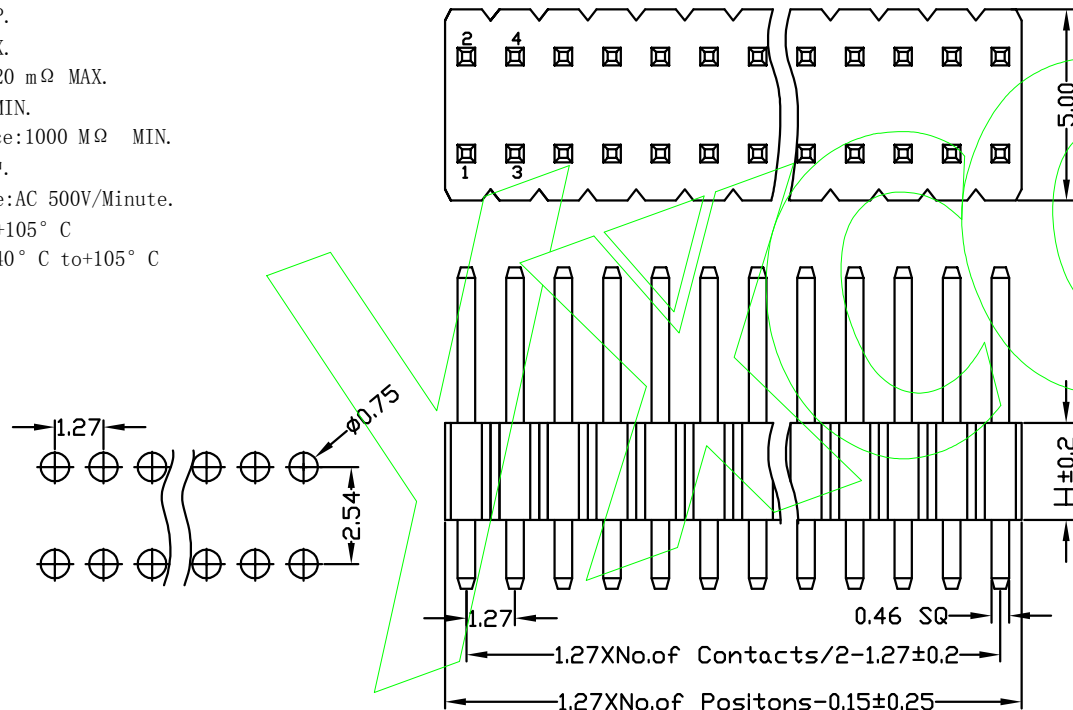

ITEM	A	B	H
Standard	1.8	2.8	1.7
Alternate			

			OPERATION		SCALE		Fit		东莞市宇熙精密连接器有限公司 www.yxcon.com Dongguan Yuxi Electronic Co.,Ltd.	
			X.X	±0.25	UNIT		MM			
			X.XX	±0.20	SI ZE	A4	DESIGN	周芳杰 2021.6.15	PART NO	P4XX-12XXXXXXX1
			X.XXX	±0.10	SHEET	1/1	CHECK		TITLE	1.27间距 2.54排距 双排针 单塑 180度
REV	DATE	SYMBOL	MODIFICATION DESCRIPTION		Angle	±3°	PROJ.	APPROVE	Customer No.	
					DIM	TOL				

Specifications

备注 (Remark)
 1. 材料 (MATERIAL)
 胶芯: PA6T+30%G.F UL94V-0, 颜色: 黑色.
 Housing: PA6T+30%G.F UL94V-0, Color: Black
 四方针: 黄铜, 镍底30u"MIN, 表面镀金0.8u"MIN
 Contact: Brass, 0.8u"MIN GOLD PLATING OVER ALL
 30u" MIN NICKEL UNDERPLATING OVER ALL

2. 特性 (characteristics):
 额定电流: 1 AMP
 Rating Current: 1 AMP.
 接触阻抗: 20 mΩ MAX.
 Contact Resistance: 20 mΩ MAX.
 绝缘阻抗: 1000 MΩ MIN.
 Insulating Resistance: 1000 MΩ MIN.
 耐电压: AC 500V/分钟.
 Withstanding Voltage: AC 500V/Minute.
 温度范围: -40° C to +105° C
 Temperature Range: -40° C to +105° C

Ordering Information

P4XX-22 XX XX X S XXX X 1

HEIGHT OF HOUSING	NO. OF PINS PER ROW	Contact Full of Gold	Plating Semi-gold	INSULATOR LENGTH MATERIAL OF	PACKING
17: 1.7mm 25: 2.54mm	2-50P	A0=0.8u" A1=1u" A2=1.5u" A3=2u" A4=3u" A5=5u" A6=10u" A7=15u" A8=20u" A9=30u"	B0=0.8U" B1=1U" B2=1.5U" B3=2U" B4=3U" B5=5U" B6=10U" B7=15U" B8=20U" B9=30U"	E: PA6T C: PA9T D: LCP	A: PE Bag B: Tape & Reel C: Tube D: Tube+CAP E: Tray

\$1=0 di nary Ti n Pl ated
 \$2=Mat te Ti n Pl ated
 \$3=Ti n-pl ated H gh-t emper at ure

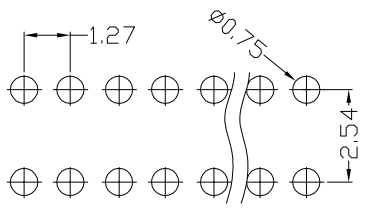
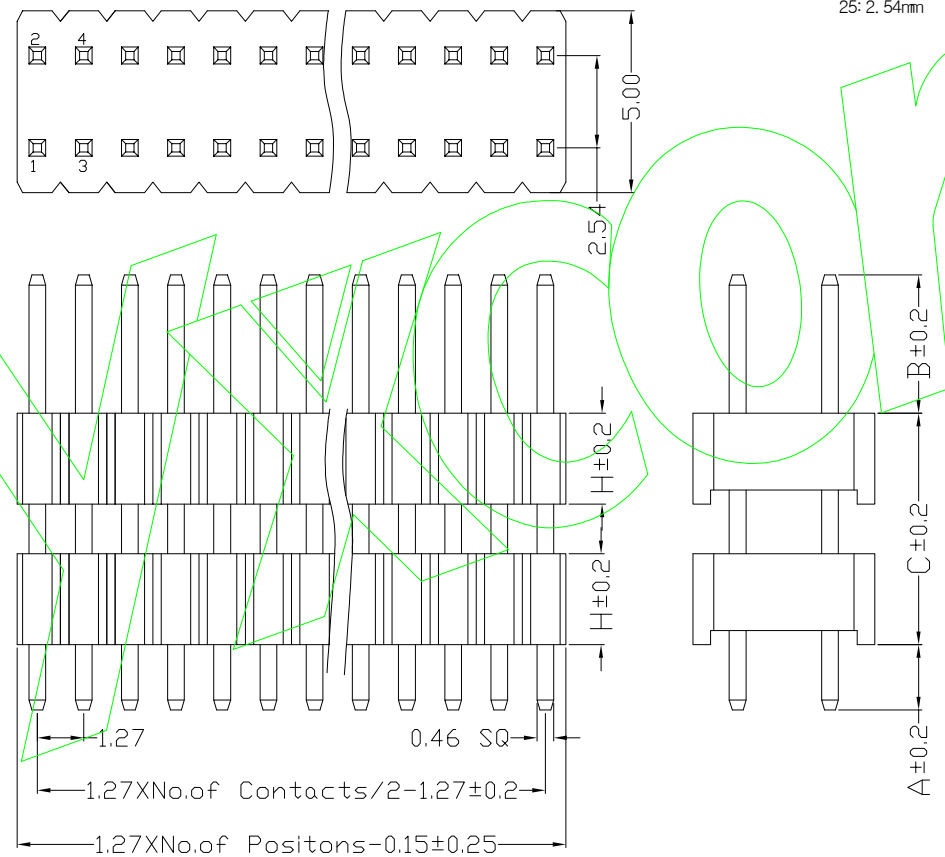

ITEM	A	B	H
Standard	1.8	2.8	1.7
Alternate			

			OPERATION		SCALE		Fit		东莞市宇熙精密连接器有限公司 www.yxcon.com Dongguan Yuxi Electronic Co.,Ltd.	
			X.X	±0.25	UNIT		MM			
			X.XX	±0.20	SIZE	A4	DESIGN	周芳杰 2021.6.15	PART NO	P4XX-22XXXXXXX1
			X.XXX	±0.10	SHEET	1/1	CHECK		TITLE	1.27间距 2.54排距 双排针 双塑 180度
REV	DATE	SYMBOL	MODIFICATION DESCRIPTION		Angle	±3°	PRQJ.	APPROVE	Customer No.	
					DIM	TOL				

Specifications

备注 (Remark)
 1. 材料 (MATERIAL)
 胶芯: PA6T+30%G.F UL94V-0, 颜色: 黑色.
 Housing: PA6T+30%G.F UL94V-0, Color: Black
 四方针: 黄铜, 镍底30u"MIN, 表面镀金0.8u"MIN
 Contact: Brass, 0.8u"MIN GOLD PLATING OVER ALL
 30u" MIN NICKEL UNDERPLATING OVER ALL

2. 特性 (characteristics):
 额定电流: 1 AMP
 Rating Current: 1 AMP.
 接触阻抗: 20 mΩ MAX.
 Contact Resistance: 20 mΩ MAX.
 绝缘阻抗: 1000 MΩ MIN.
 Insulating Resistance: 1000 MΩ MIN.
 耐电压: AC 500V/分钟.
 Withstanding Voltage: AC 500V/Minute.
 温度范围: -40° C to +105° C
 Temperature Range: -40° C to +105° C

Ordering Information

P4XX-22 XX XX X S XXX X 2

HEIGHT OF HOUSING	NO. OF PINS PER ROW	Contact Full of Gold	Plating Semi-gold	INSULATOR LENGTH MATERIAL: OF	PACKING
17: 1.7mm 25: 2.54mm	2-50P	A0=0.8u" A1=1u" A2=1.5u" A3=2u" A4=3u" A5=5u" A6=10u" A7=15u" A8=20u" A9=30u"	B0=0.8U" B1=1U" B2=1.5U" B3=2U" B4=3U" B5=5U" B6=10U" B7=15U" B8=20U" B9=30U"	B: PA6T C: PA9T D: LCP	A: PE Bag B: Tape & Reel C: Tube D: Tube+CAP E: Tray

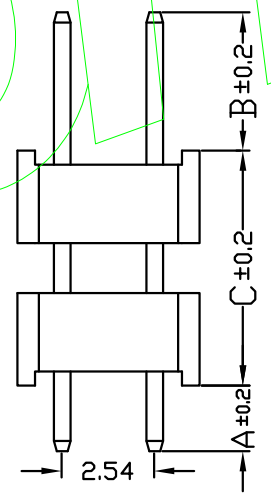
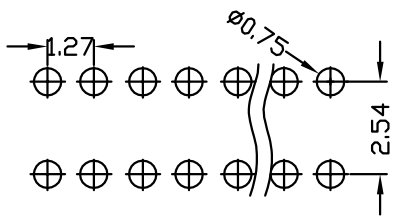
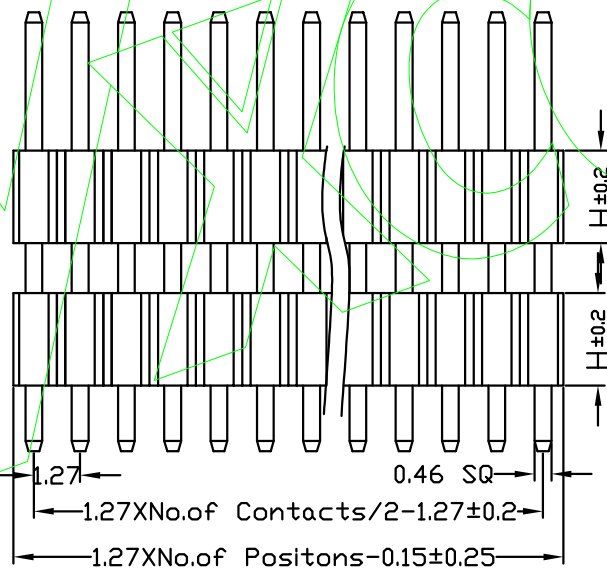
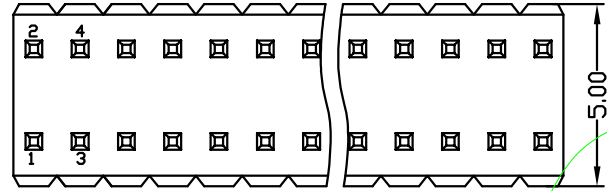

ITEM	A	B	H
Standard	1.8	2.8	2.8
Alternate	6.0	1.7	2.54

REV	DATE	SYMBOL	MODIFICATION DESCRIPTION	OPERATION	SCALE	Fit	东莞市宇熙精密连接器有限公司 www.yxcon.com Dongguan Yuxi Electronic Co., Ltd.					
				X.X ±0.25	UNIT	MM	SIZE	A4	DESIGN	周芳杰 2021.6.15	PART NO	P4XX-22XXXXXXX2
				X.XX ±0.20	SHEET	1/1	CHECK				TITLE	1.27间距 2.54排距 双排针 双塑 180度 反塑
				X.XXX ±0.10	PRQJ.	⊕	APPROVE				Customer No.	
				Angle ±3°								
				DIM TOL								