

Specifications

備注 (Remark)

1. 材料 (Material)

膠芯: PA9T/LCP+30%G. F UL94V-0, 顏色: 黑色

Housing: PA9T/LCP+30%G. F UL94V-0, Color: Black

端子: 黃銅

Contact: Brass

2. 特性 (characteristics):

額定電流: 2.00AMP

Rating Current: 2.00AMP

接觸阻抗: 20mΩ Max

Contact Resistance: 20mΩ Max

絕緣阻抗: 1000MΩ Min

Insulating Resistance: 1000 MΩ MIN

耐電壓: AC 500V

Withstanding Voltage: AC 500V/Minute

溫度範圍: -40° C to +105° C

Temperature Range: -40° C to +105° C

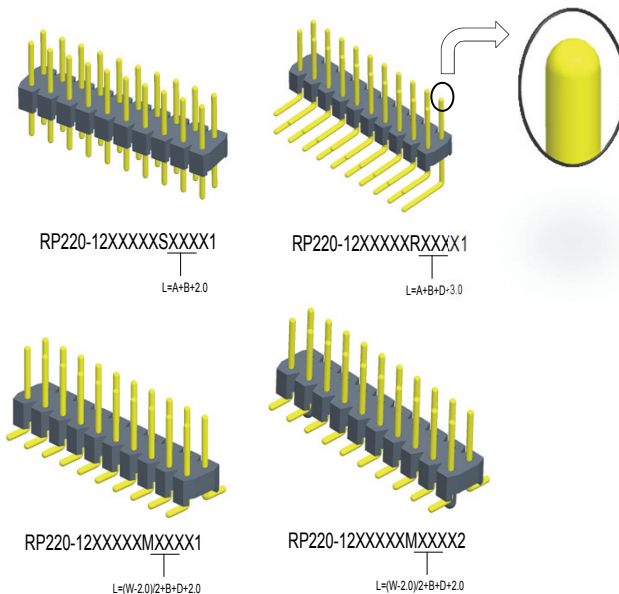

Mating With/配對母座:
RF2

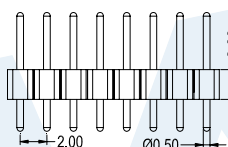
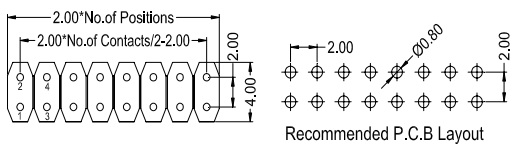
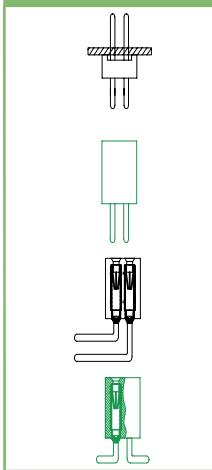

Dimension antitheses list			
ITEM	A	B	
Standard	2.80	4.00	
Alternate	4.00	2.80	

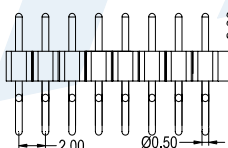
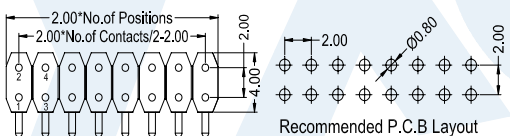

Dimension antitheses list			
ITEM	A	B	D
Standard	2.80	4.00	0.10
Alternate	4.00	2.80	0.75

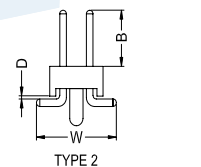
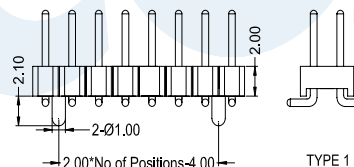
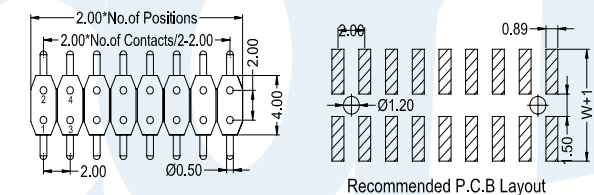

Dimension antitheses list			
ITEM	B	D	W
Standard	4.00	0.10	6.50
Alternate	2.80	0.75	

R

ROUND

RP220-12

XX

XX

X

X

XXX

X

X

No.Of Pins Per Row
02~50P

Contact Plating
Full Of Gold
A0=0.8u"
~
B0=0.8u"

Insulator Material:
B:PA6T
C:PA9T
D:LCP

Contact Shape:
S: Straight
R: Right angle
M: SMT

Length Of Terminal

Packing
A: PE Bag
B: Tape & Reel
C: Tube
D: Tube+CAP
E: Tray

Journal Number
1: Type1
2: Type2

A9=30u" B9=30u"
S1=Ordinary Tin Plated
S2=Matte Tin Plated
S3=Tin-plated High-temperature

[Http://www.yxcon.com](http://www.yxcon.com)

[E-mail:yx@yxcon.com](mailto:yx@yxcon.com)

YUXI DONGGUAN (東莞)
YUXI TAIWAN (台灣)

TEL:+86 769 85397456
TEL:+886 3313 2933

FAX:+86 769 85396015
FAX:+886 3313 2935

Specifications

備注 (Remark)

1. 材料 (Material)

膠芯: PA9T/LCP+30%G. F UL94V-0, 顏色: 黑色

Housing: PA9T/LCP+30%G. F UL94V-0, Color: Black

端子: 黃銅

Contact: Brass

2. 特性 (characteristics):

額定電流: 2.00AMP

Rating Current: 2.00AMP

接觸阻抗: 20mΩ Max

Contact Resistance: 20mΩ Max

絕緣阻抗: 1000MΩ Min

Insulating Resistance: 1000 MΩ MIN

耐電壓: AC 500V

Withstanding Voltage: AC 500V/Minute

溫度範圍: -40° C to +105° C

Temperature Range: -40° C to +105° C

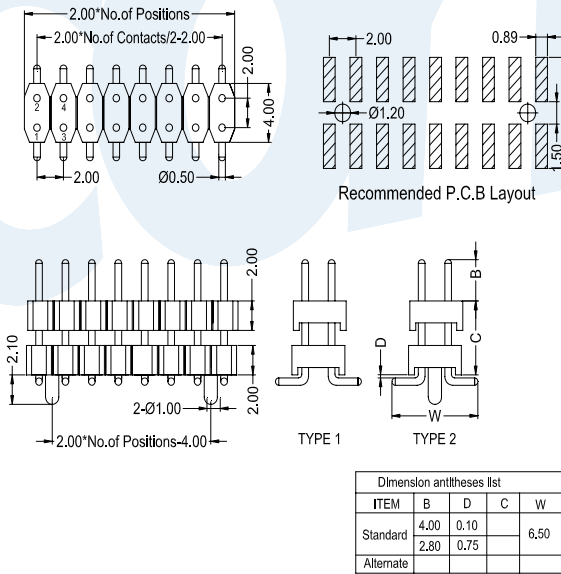
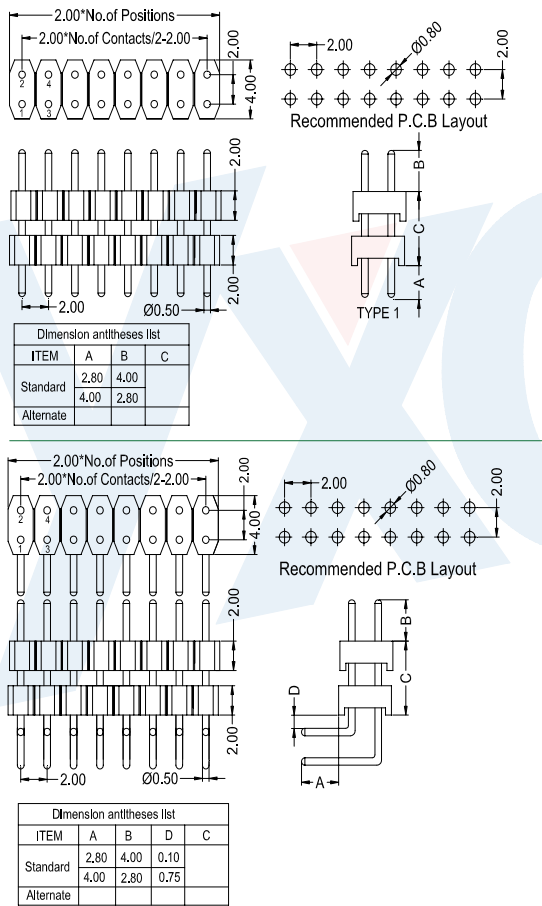
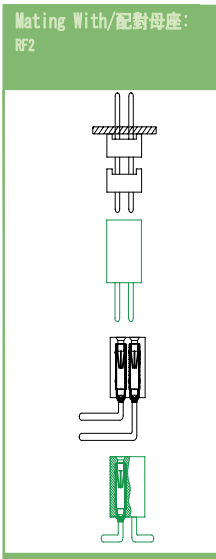
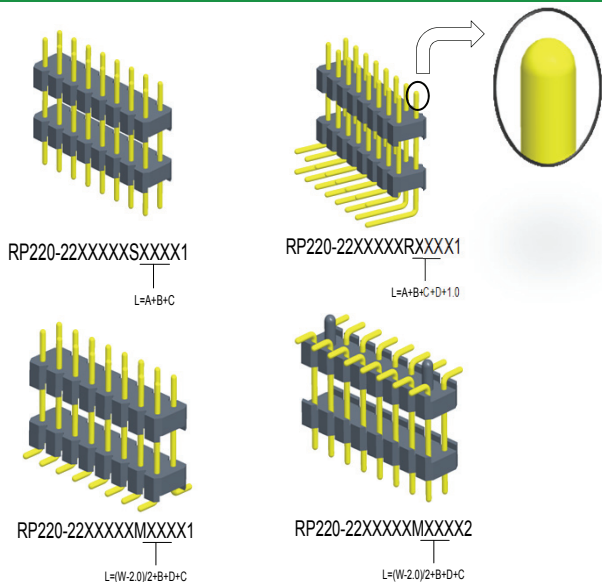

R
ROUND

RP220-22	XX	XX	X	X	XXX	X	X
No.Of Pins Per Row	Contact Plating	Insulator Material:	Contact Shape:	Length Of Terminal	Packing	Journal Number	
02~50P	Full Of Gold A0=0.8u" ~ A9=30u" S1=Ordinary Tin Plated S2=Matte Tin Plated S3=Tin-plated High-temperature	Semi-Gold B0=0.8U" ~ B9=30U"	S: Straight R: Right angle M: SMT		A: PE Bag B: Tape & Reel C: Tube D: Tube+CAP E: Tray	1: Type1 2: Type2	

Specifications

備注 (Remark)

1. 材料 (Material)

膠芯: PPS+30%G, F UL94V-0, 顏色: 黑色

Housing: PPS+30%G, F UL94V-0, Color: Black

端子: 黃銅

Contact: Brass CuZn 36Pb3 (C3600)

相配針: ϕ 0.47mm

Connecting Pin: ϕ 0.47mm

2. 特性 (characteristics):

額定電流: 3.0AMP

Rating Current: 3.0AMP

接觸阻抗: 10m Ω Max

Contact Resistance: 10m Ω Max

絕緣強度: Min 1000V RMS

Dielectric strength: Min 1000V RMS

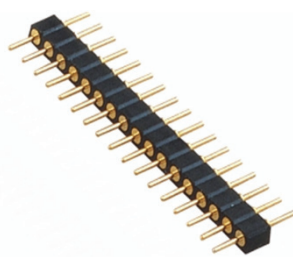

RP228-1XX0XGS1001

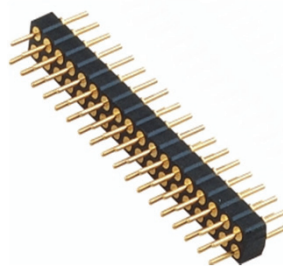

RP228-2XX2XGS1001

Mating With/配對公座:
RP2

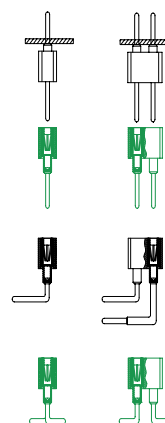

R
ROUND

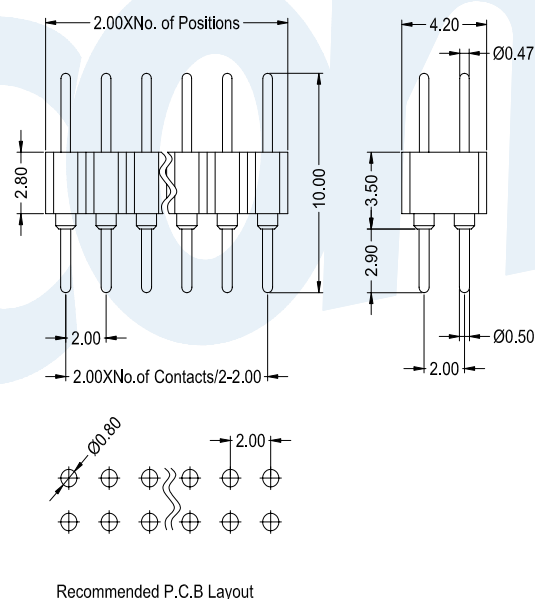
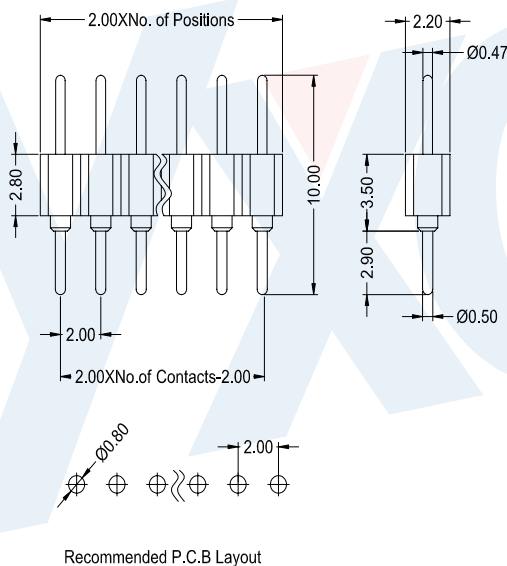

RF228-X

Height of Housing:
28:2.8mm

No. of Row:
1: Single Row
2: Dual Row

XX

No. of Pins Per Row:
02~40P

X

No. of Array Pitch
0: No Pitch
2: 2.0mm

X

Contact Plating
A=1u"
B=2u"
~
E=15u"
F=30u"
S=Ordinary Tin Plated
H=Half Gold Plated Tin

G

Insulator Material:
G: PPS

S

100

Length Of Terminal

1

Specifications

備注 (Remark)

1. 材料 (Material)

膠芯: PPS+30%G. F UL94V-0, 顏色: 黑色

Housing: PPS+30%G. F UL94V-0, Color: Black

端子: 黃銅

Contact: Brass CuZn 36Pb3 (C3600)

相配針: ϕ 0.47mm

Connecting Pin: ϕ 0.47mm

2. 特性 (characteristics):

額定電流: 3.0AMP

Rating Current: 3.0AMP

接觸阻抗: 10m Ω Max

Contact Resistance: 10m Ω Max

絕緣強度: Min 1000V RMS

Dielectric strength: Min 1000V RMS



RP228-1XX0XGR1221

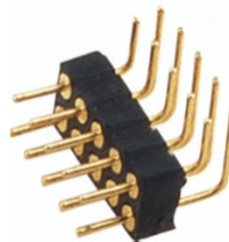

RP228-1XX2XGR1221

Mating With/配對母座:
RF2

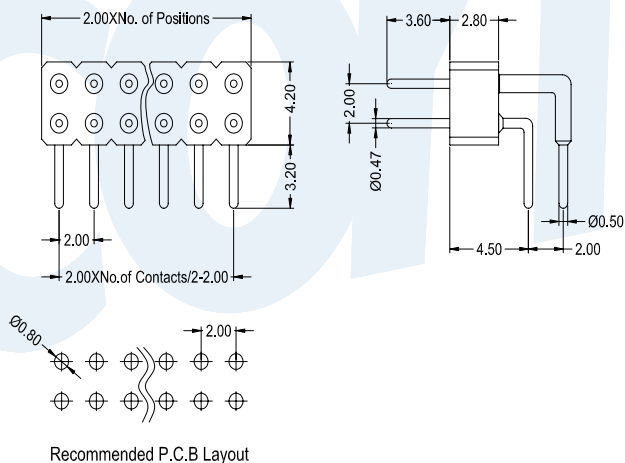
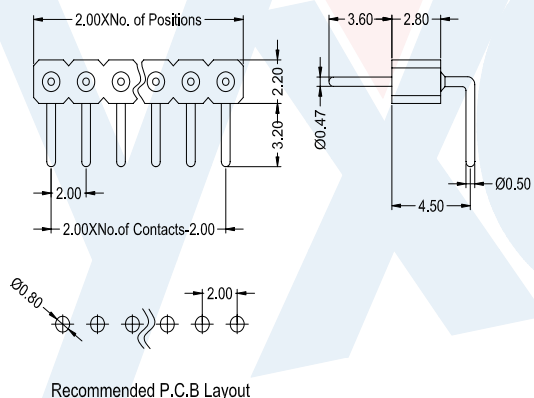
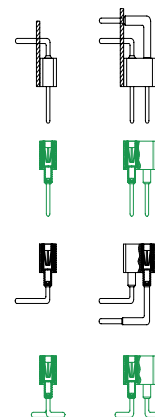

R

ROUND

RP228-X

Height of Housing:
28:2.8mm

No. of Row:
1: Single Row
2: Dual Row

XX

No. of Pins Per Row:
02~40P

X

No. of Array Pitch
0: No Pitch
2: 2.0mm

X

Contact Plating
A=1u"
S=2u"
~
E=15u"
F=30u"
S=Ordinary Tin Plated
H=Half Gold Plated Tin

G

Insulator Material:
G: PPS

R

122

Length Of Terminal

1

Specifications

備注 (Remark)

1. 材料 (Material)

膠芯: PPS+30%G, F UL94V-0, 顏色: 黑色

Housing: PPS+30%G, F UL94V-0, Color: Black

端子: 黃銅

Contact: Brass CuZn 36Pb3 (C3600)

相配針: ϕ 0.47mm

Connecting Pin: ϕ 0.47mm

2. 特性 (characteristics):

額定電流: 3.0AMP

Rating Current: 3.0AMP

接觸阻抗: 10m Ω Max

Contact Resistance: 10m Ω Max

絕緣強度: Min 1000V RMS

Dielectric strength : Min 1000V RMS



RP228-1XX0XGM1011

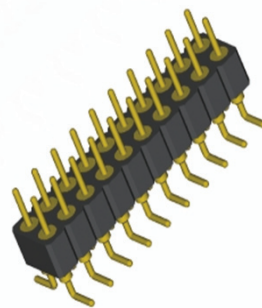

RP228-1XX2XGM1011

Mating With/配對母座:
RF2

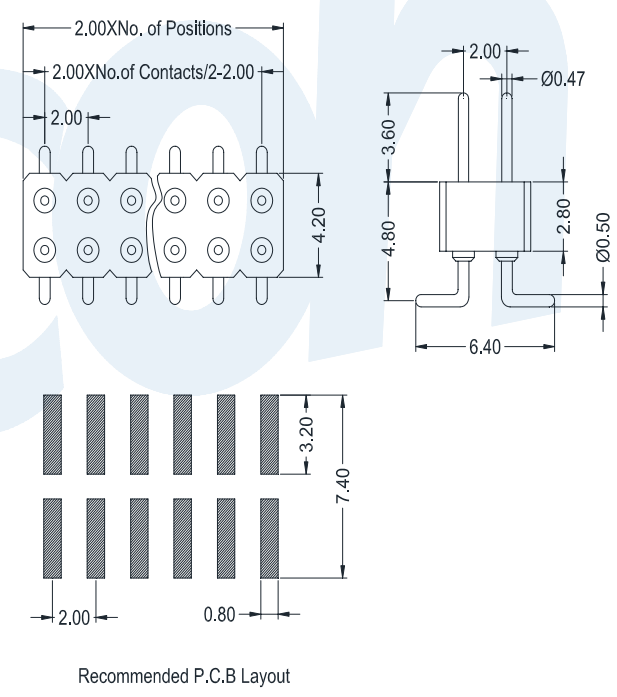
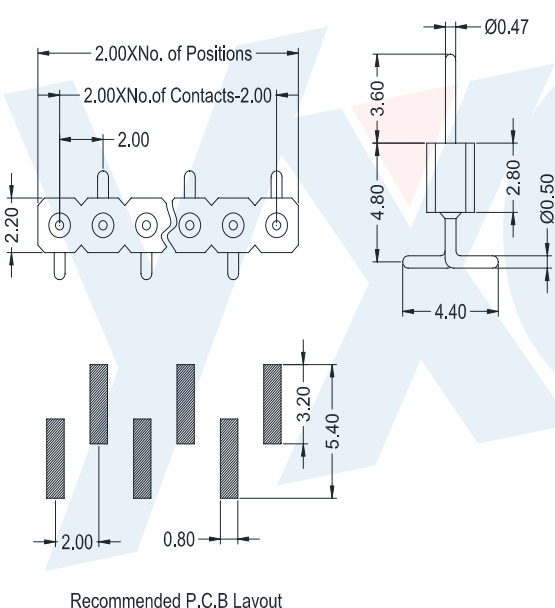
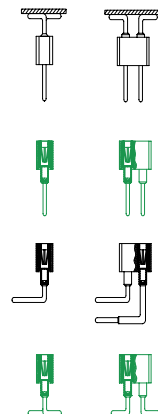

RP228-X	XX	X	X	G	M	101	1
Height of Housing: 28:2.8mm	No. of Row: 1: Single Row 2: Dual Row	No. of Pins Per Row: 2~40P	No. of Array Pitch: 0: No Pitch 2: 2.0mm	Contact Plating: A=1u" B=2u" ~ E=15u" F=30u" S=Ordinary Tin Plated H=Half Gold Plated Tin	Insulator Material: G: PPS	Length Of Terminal	