

Specifications

備注 (Remark)

1. 材料 (Material)

膠芯: PA9T/LCP+30%G. F UL94V-0, 顏色: 黑色

Housing: PA9T/LCP+30%G. F UL94V-0, Color: Black

端子: 黃銅

Contact: Brass

2. 特性 (characteristics):

額定電流: 3.00AMP

Rating Current: 3.00AMP

接觸阻抗: 20mΩ Max

Contact Resistance: 20mΩ Max

絕緣阻抗: 1000MΩ Min

Insulating Resistance: 1000 MΩ Min

耐電壓: AC 500V/分鐘

Withstanding Voltage: AC 500V/Minute

溫度範圍: -40° C to +105° C

Temperature Range: -40° C to +105° C

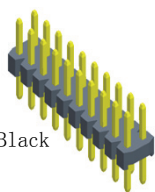

P1XX-12XXXXXSXXXX1

L=A+B+H

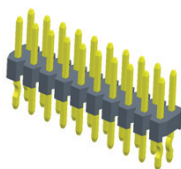

P125-12XXXXXSXXXX2

L=A+B+H

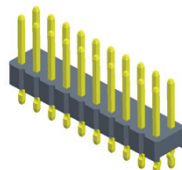

P125-12XXXXXCXXXX1

L=A+B+2.5



P1XX-12XXXXXRXXXX1

L=A+B+D+H+1.23

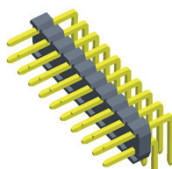

P1XX-12XXXXRXXXXX2

L=A+B+D+H+1.23

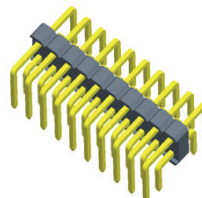

P125-12XXXXRXXXXX3

L=2A+2D+H+2.5

Mating With/配對母座:

- F135/F136/F145/F150/F157/F160
- F168/F169/F170/F171/F175/F184
- F185/F186/F111

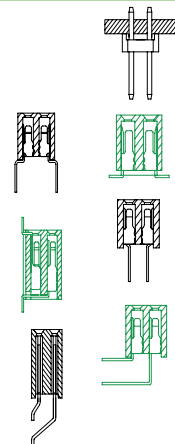

Dimension anitheses list			
ITEM	A	B	H
Standard	3.0	3.0/4.0/5.0/6.0	1.0 1.7 2.5 3.0
Alternate			1.5 2.0 2.8

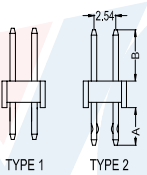
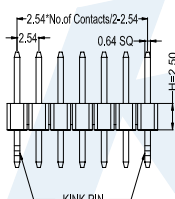
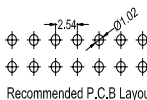
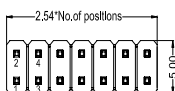

Dimension anitheses list				
ITEM	A	B	D	H
Standard	3.00	3.0/4.0/5.0/6.0	1.2/2.0	1.0 1.7 2.5 3.0
Alternate				1.5 2.0 2.8

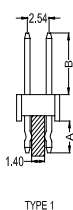
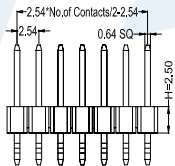
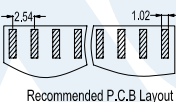
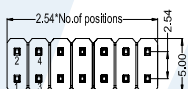
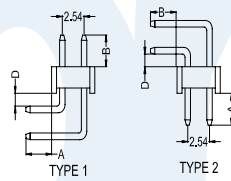
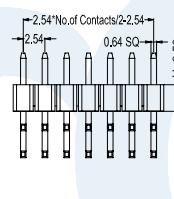
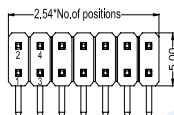

Dimension anitheses list			
ITEM	A	B	H
Standard	3.0	3.0/4.0/5.0/6.0	1.0 1.7 2.5 3.0
Alternate			1.5 2.0 2.8

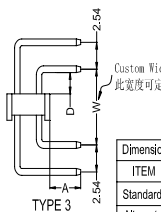
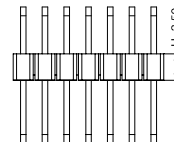
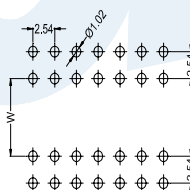
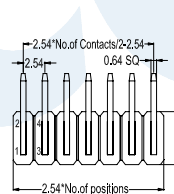

Dimension anitheses list				
ITEM	A	D	W	H
Standard	3.6	1.2	5.5	1.0 1.7 2.5 3.0
Alternate				1.5 2.0 2.8

- P 110 - 12
- P 115 - 12
- P 117 - 12
- P 120 - 12
- P 125 - 12
- P 128 - 12
- P 130 - 12

XX

XX

X

X

XXX

X

X

No.Of Pins
Per Row
02~40P

Contact Plating
Full Of Gold A0=0.8u"
Semi-Gold B0=0.8U"
~
A9=30u" B9=30U"
S1=Ordinary Tin Plated
S2=Matte Tin Plated
S3=Tin-plated High-temperature

Insulator Material:
A:PBT
B:PA6T
C:PA9T
D:LCP

Contact Shape:
S: Straight
R: Right Angle
C: K Feet/Splint

Length Of Terminal
A: PE Bag
B: Tape & Reel
C: Tube
D: Tube+CAP
E: Tray

Journal Number
1: Type1
2: Type2
3: Type3

Specifications

備注 (Remark)

1. 材料 (Material)

膠芯: PA9T/LCP+30%G. F UL94V-0, 顏色: 黑色

Housing: PA9T/LCP+30%G. F UL94V-0, Color: Black

端子: 黃銅

Contact: Brass

2. 特性 (characteristics):

額定電流: 3.00AMP

Rating Current: 3.00AMP

接觸阻抗: 20mΩ Max

Contact Resistance: 20mΩ Max

絕緣阻抗: 1000MΩ Min

Insulating Resistance: 1000 MΩ Min

耐電壓: AC 500V/分钟

Withstanding Voltage: AC 500V/Minute

溫度範圍: -40° C to +105° C

Temperature Range: -40° C to +105° C

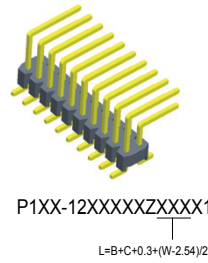
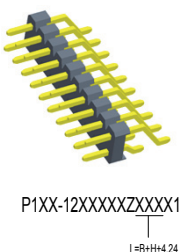
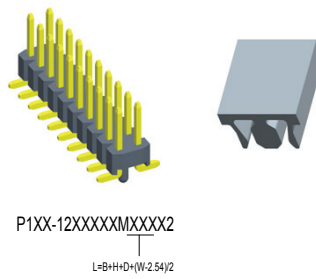
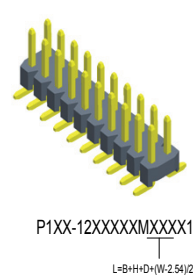

Mating With/配對母座:
F135/F136/F145/F150/F157/F160
F168/F169/F170/F171/F175/F184
F185/F186/F111

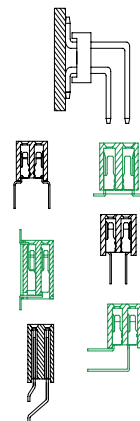

PIN HEADER

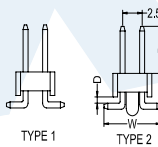
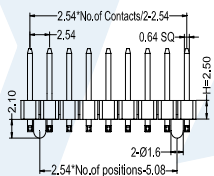
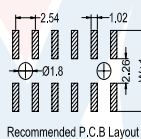
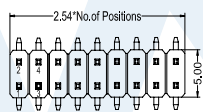

Dimension anitheses list				
ITEM	B	D	W	H
Standard	3.0/4.0/5.0/6.0	0.2/0.6	7.5	1.0 1.7 2.5 3.0
Alternate	1.5	2.0	2.8	1.5 2.0 2.8

Dimension anitheses list		
ITEM	B	H
Standard	3.0/4.0/5.0/6.0	1.0 1.7 2.5 3.0
Alternate	1.5	2.0 2.8

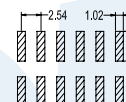
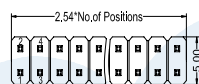

Recommended P.C.B Layout

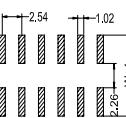
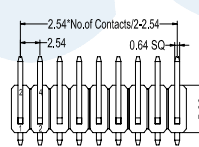
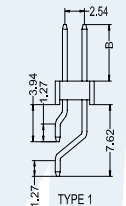
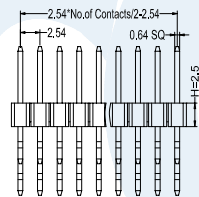

Recommended P.C.B Layout

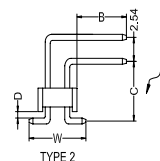
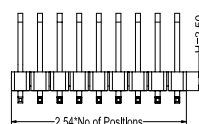

Dimension anitheses list				
ITEM	B	C	D	W
Standard	3.0/4.0/5.0/6.0	0.70	7.50	1.0 1.7 2.5 3.0
Alternate	1.5	2.0	2.8	1.5 2.0 2.8

P 110 - 1 2	XX	XX	X	X	XXX	X	X
P 115 - 1 2							
P 117 - 1 2	No. Of Pins	Contact Plating	Insulator Material:	Contact Shape:	Length Of Terminal	Packing	Journal Number
P 120 - 1 2	02~40P	Full Of Gold A0=0.8u" ~ A9=30u" S1=Ordinary Tin Plated S2=Matte Tin Plated S3=Tin-plated High-temperature	Semi-Gold B0=0.8U" ~ B9=30U"	A: PBT B: PA6T C: PA9T D: LCP	M: SMT Z: 90° SMT	A: PE Bag B: Tape & Reel C: Tube D: Tube+CAP E: Tray	1: Type1 2: Type2
P 125 - 1 2							
P 128 - 1 2							
P 130 - 1 2							

Http://www.yxcon.com E-mail:yx@yxcon.com

YUXI DONGGUAN (東莞) TEL:+86 769 85397456 FAX:+86 769 85396015
YUXI TAIWAN (台灣) TEL:+886 3313 2933 FAX:+886 3313 2935

Specifications

備注 (Remark)

1. 材料 (Material)

膠芯: PA9T/LCP+30%G. F UL94V-0, 顏色: 黑色
Housing: PA9T/LCP+30%G. F UL94V-0, Color: Black
端子: 黃銅

Contact: Brass

2. 特性 (characteristics):

額定電流: 3.00AMP
Rating Current: 3.00AMP
接觸阻抗: 20mΩ Max
Contact Resistance: 20mΩ Max
絕緣阻抗: 1000MΩ Min
Insulating Resistance: 1000 MΩ Min
耐電壓: AC 500V/分种
Withstanding Voltage: AC 500V/Minute
溫度範圍: -40° C to +105° C
Temperature Range: -40° C to +105° C

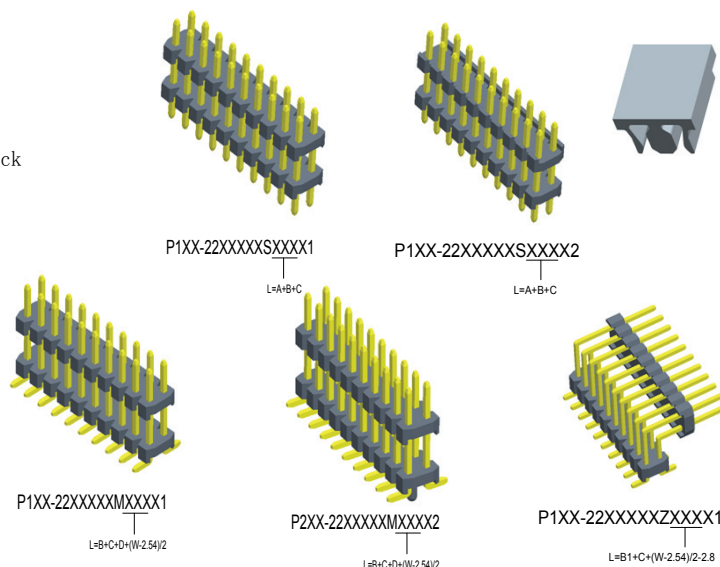

Mating With/配對母座:
F135/F136/F145/F150/F157/F160
F168/F169/F170/F171/F175/F184
F185/F186/F111

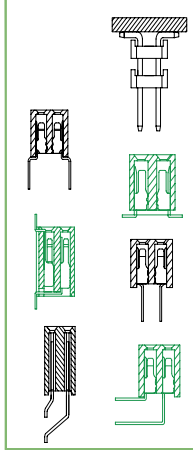

ITEM	B	C	D	W	H
Standard	3.04,0.5,0.6,0	0.60	7.50		1.0 1.7 2.5 3.0
Alternate					1.5 2.0 2.8

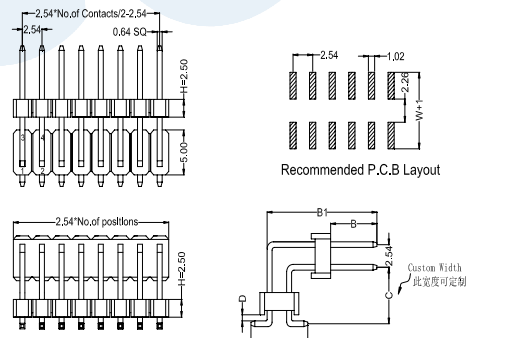
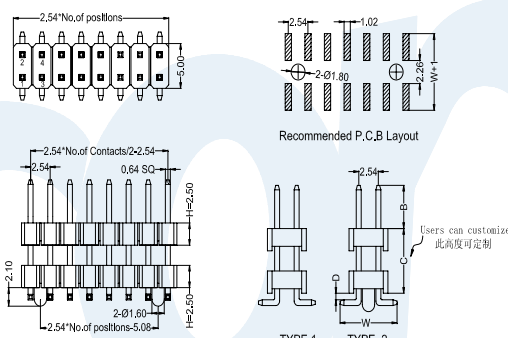
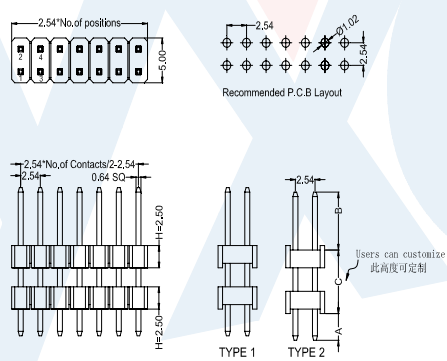

ITEM	A	B	C	H
Standard	3.00	3.04,0.5,0.6,0		1.0 1.7 2.5 3.0
Alternate		1.5 2.0 2.8		

ITEM	B	B1	C	D	W	H
Standard	3.04,0.5,0.6,0		0.70	7.50		1.0 1.7 2.5 3.0
Alternate						1.5 2.0 2.8

P 110 - 22	XX	XX	X	X	XXX	X	X
P 115 - 22							
P 117 - 22							
P 120 - 22							
P 125 - 22							
P 128 - 22							
P 130 - 22							

No. Of Pins Per Row: 02~40P

Contact Plating: Full Of Gold, Semi-Gold, A0=0.8u", B0=0.8U", A9=30u", B9=30U", S1=Ordinary Tin Plated, S2=Matte Tin Plated, S3=Tin-plated High-temperature

Insulator Material: A:PBT, B:PA6T, C:PA9T, D:LCP

Contact Shape: S: Straight, M: SMT, Z: 90° SMT

Length Of Terminal: B1, B, 2.34

Packing: A: PE Bag, B: Tape & Reel, C: Tube, D: Tube+CAP, E: Tray

Journal Number: 1: Type1, 2: Type2

Specifications

備注 (Remark)

1. 材料 (Material)

膠芯: PA9T/LCP+30%G. F UL94V-0, 顏色: 黑色
Housing: PA9T/LCP+30%G. F UL94V-0, Color: Black
端子: 黃銅

Contact: Brass

2. 特性 (characteristics):

額定電流: 3.00AMP
Rating Current: 3.00AMP
接觸阻抗: 20mΩ Max
Contact Resistance: 20mΩ Max
絕緣阻抗: 1000MΩ Min
Insulating Resistance: 1000 MΩ Min
耐電壓: AC 500V/分钟
Withstanding Voltage: AC 500V/Minute
溫度範圍: -40° C to +105° C
Temperature Range: -40° C to +105° C

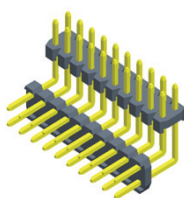

P1XX-22XXXXRXXXX1

$$L=A+B+D1+D2+2H+0.32$$

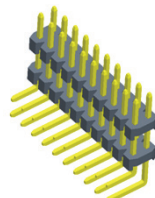

P1XX-22XXXXRXXXX2

$$L=A+B+C+D+1.25$$

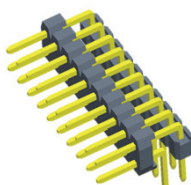

P1XX-12XXXXRXXXX3

$$L=A+B+D+H+1.23$$

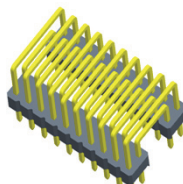

P125-22XXXXRXXXX4

$$L=2B+W-6.5$$

Mating With/配對母座:
F135/F136/F145/F150/F157/F160
F168/F169/F170/F171/F175/F184
F185/F186/F111

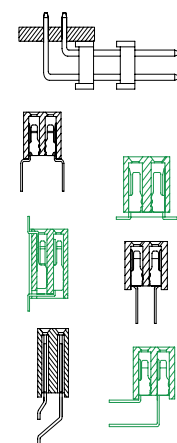

Dimension anitheses list					
ITEM	A	B	D1	D2	H
Standard	3.00	3.0/4.0/5.0/6.0			1.0 1.7 2.5 3.0
Alternate					1.5 2.0 2.8

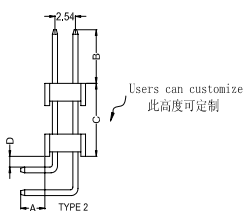
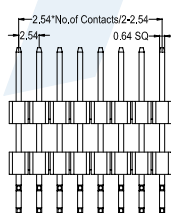
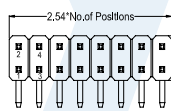
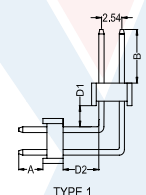
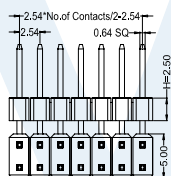
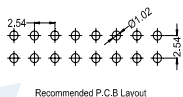
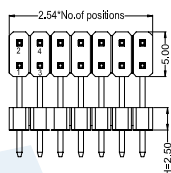

Dimension anitheses list					
ITEM	A	B	C	D	H
Standard	3.00	3.0/4.0/5.0/6.0		1.20	1.0 1.7 2.5 3.0
Alternate					1.5 2.0 2.8

Dimension anitheses list					
ITEM	A	B	D	H	
Standard	3.00	3.0/4.0/5.0/6.0	0.6/1.2	1.0	1.7 2.5 3.0
Alternate				1.5	2.0 2.8

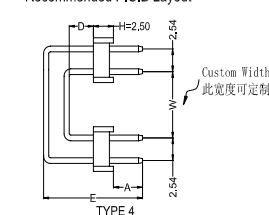
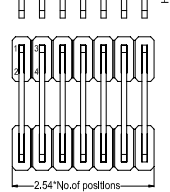
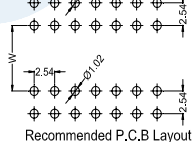
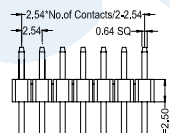
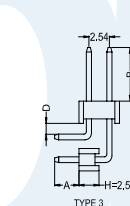
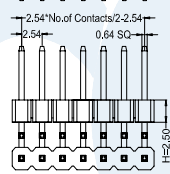
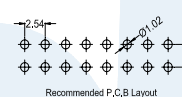
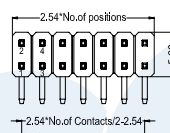

Dimension anitheses list					
ITEM	A	E	D	H	
Standard	3.60			1.0	1.7 2.5 3.0
Alternate				1.5	2.0 2.8

- P 110 - 22
- P 115 - 22
- P 117 - 22
- P 120 - 22
- P 125 - 22
- P 128 - 22
- P 130 - 22

XX

No. Of Pins Per Row
02~40P

XX

Contact Plating
Full Of Gold A0=0.8u"
Semi-Gold B0=0.8U"
~
A9=30u" B9=30U"
S1=Ordinary Tin Plated
S2=Matte Tin Plated
S3=Tin-plated High-temperature

X

Insulator Material:
A:PBT
B:PA6T
C:PA9T
D:LCP

R

Contact Shape:
R:Right Angle

XXX

Length Of Terminal

Packing
A:PE Bag
B:Tape & Reel
C:Tube
D:Tube+CAP
E:Tray

X

Journal Number
1:Type1
2:Type2
3:Type3
4:Type4

Http://www.yxcon.com

E-mail:yx@yxcon.com

YUXI DONGGUAN (東莞)
YUXI TAIWAN (台灣)

TEL:+86 769 85397456
TEL:+886 3313 2933

FAX:+86 769 85396015
FAX:+886 3313 2935

Specifications

備注 (Remark)

1. 材料 (Material)

膠芯: PA9T/LCP+30%G. F UL94V-0, 顏色: 黑色

Housing: PA9T/LCP+30%G. F UL94V-0, Color: Black

端子: 黃銅

Contact: Brass

2. 特性 (characteristics):

額定電流: 3.00AMP

Rating Current: 3.00AMP

接觸阻抗: 20mΩ Max

Contact Resistance: 20mΩ Max

絕緣阻抗: 1000MΩ Min

Insulating Resistance: 1000 MΩ Min

耐電壓: AC 500V/分鐘

Withstanding Voltage: AC 500V/Minute

溫度範圍: -40° C to +105° C

Temperature Range: -40° C to +105° C

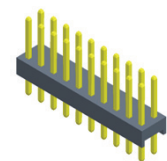

P125-12XXXXX1
L=A+B+2.5

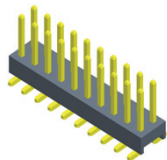

P125-12XXXXM1
L=B+2.5+D+(W-2.54)/2

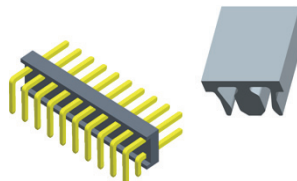

P125-12XXXXR1
L=A+B+D+H+1.23

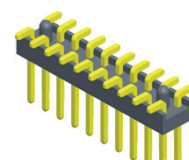

P125-12XXXXM2
L=B+2.5+D+(W-2.54)/2

Mating With/配對母座:
 F135/F136/F145/F150/F157/F160
 F168/F169/F170/F171/F175/F184
 F185/F188/F111

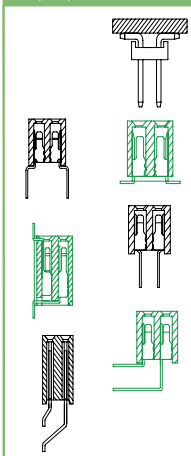

Dimension anitheses list		
ITEM	A	B
Standard	2.4/3.0	3.0/4.0/5.0/6.0
Alternate		

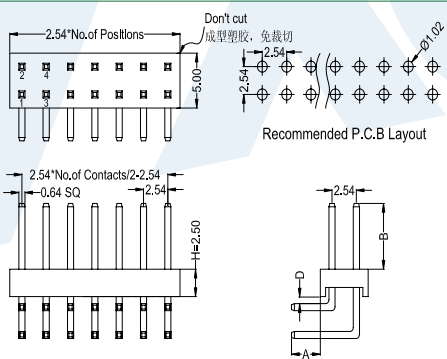
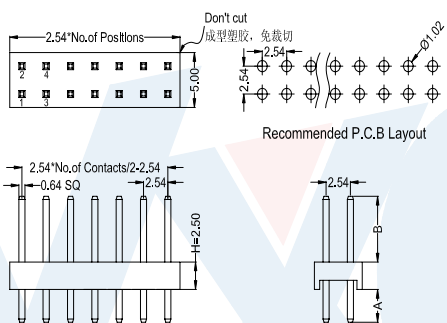

Dimension anitheses list			
ITEM	A	B	D
Standard	3.00	3.0/4.0/5.0/6.0	1.2/2.0
Alternate			

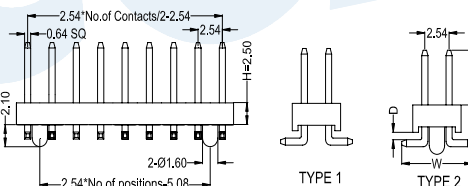
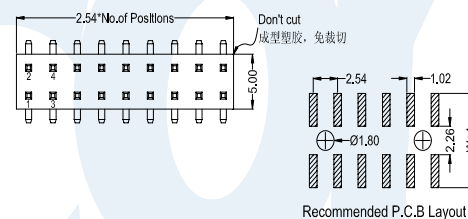

Dimension anitheses list				
ITEM	B	D	W	
Standard	3.0/4.0/5.0/6.0	0.2	0.6	7.5
Alternate				

P 1 2 5 - 1 2

XX

XX

X

X

XXX

X

X

No.Of Pins Per Row
02~40P

Contact Plating
Full Of Gold
A0=0.8u"
~
A9=30u"
S1=Ordinary Tin Plated
S2=Matte Tin Plated
S3=Tin-plated High-temperature

Insulator Material:
A:PBT
B:PA6T
C:PA9T
D:LCP

Contact Shape:
S: Straight
R: Right Angle
M: SMT

Length Of Terminal

Packing
A: PE Bag
B: Tape & Reel
C: Tube
D: Tube+CAP
E: Tray

Journal Number
1: Type1
2: Type2

[Http://www.yxcon.com](http://www.yxcon.com)

E-mail: yx@yxcon.com

YUXI DONGGUAN (東莞)
YUXI TAIWAN (台灣)

TEL:+86 769 85397456
TEL:+886 3313 2933

FAX:+86 769 85396015
FAX:+886 3313 2935

Specifications

備注 (Remark)

1. 材料 (Material)

膠芯: PA9T/LCP+30%G. F UL94V-0, 顏色: 黑色

Housing: PA9T/LCP+30%G. F UL94V-0, Color: Black

端子: 黃銅

Contact: Brass

2. 特性 (characteristics):

額定電流: 3.00AMP

Rating Current: 3.00AMP

接觸阻抗: 20mΩ Max

Contact Resistance: 20mΩ Max

絕緣阻抗: 1000MΩ Min

Insulating Resistance: 1000 MΩ Min

耐電壓: AC 500V/分鐘

Withstanding Voltage: AC 500V/Minute

溫度範圍: -40° C to +105° C

Temperature Range: -40° C to +105° C

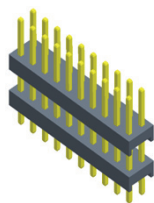

P125-22XXXXX1

$$L=A+B+C$$

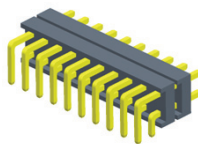

P125-12XXXXRXXXX1

$$L=A+B+C+D+1.23$$

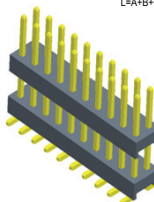

P215-22XXXXMXXXX1

$$L=B+C+D+(W/2.54)2$$

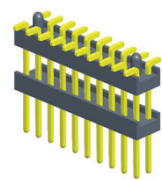

P215-22XXXXMXXXX2

$$L=B+C+D+(W/2.54)2$$

Mating With/配對母座:

F135/F136/F145/F150/F157/F160

F168/F169/F170/F171/F175/F184

F185/F186/F111

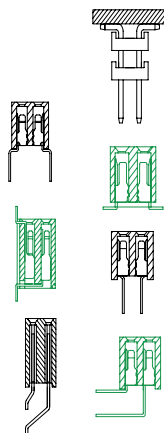

Dimension anitheses list			
ITEM	A	B	C
Standard	3.00	3.0/4.0/5.0/6.0	
Alternate			

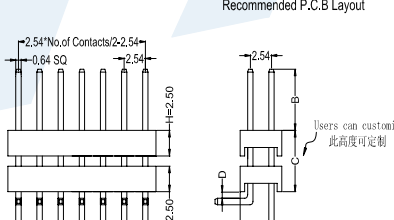
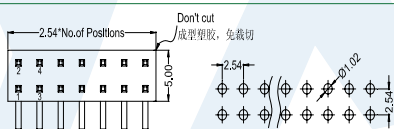
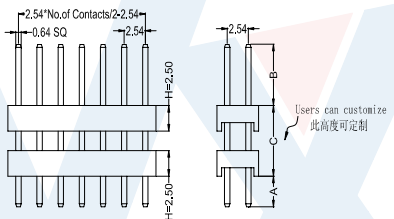
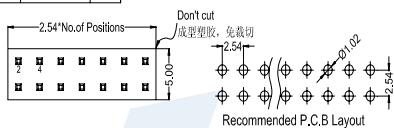

Dimension anitheses list				
ITEM	A	B	C	D
Standard	3.00	3.0/4.0/5.0/6.0		1.20
Alternate				

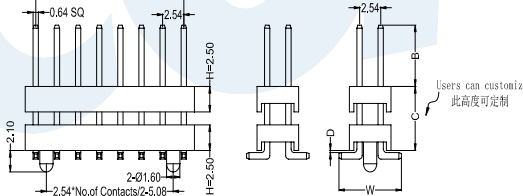
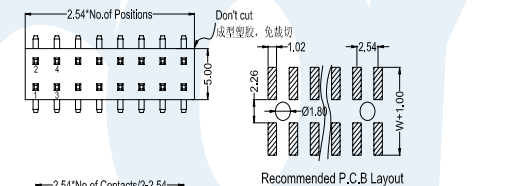

Dimension anitheses list				
ITEM	B	C	D	W
Standard	3.0/4.0/5.0/6.0		0.20/0.60	7.50
Alternate				

P 125 - 2 2

XX

XX

X

X

XXX

X

X

No. Of Pins Per Row
02~40P

Contact Plating
Full Of Gold A0=0.8u"
Semi-Gold B0=0.8U"

A9=30u" B9=30U"
S1=Ordinary Tin Plated
S2=Matte Tin Plated
S3=Tin-plated High-temperature

Insulator Material:
A: PBT
B: PA6T
C: PA9T
D: LCP

Contact Shape:
S: Straight
R: Right Angle
M: SMT

Length Of Terminal

Packing
A: PE Bag
B: Tape & Reel
C: Tube
D: Tube+CAP
E: Tray

Journal Number
1: Type1
2: Type2

Http://www.yxcon.com

E-mail:yx@yxcon.com

YUXI DONGGUAN (東莞)
YUXI TAIWAN (台灣)

TEL:+86 769 85397456
TEL:+886 3313 2933

FAX:+86 769 85396015
FAX:+886 3313 2935

Specifications

備注 (Remark)

1. 材料 (Material)

膠芯: PA9T/LCP+30%G. F UL94V-0, 顏色: 黑色

Housing: PA9T/LCP+30%G. F UL94V-0, Color: Black

端子: 黃銅

Contact: Brass

2. 特性 (characteristics):

額定電流: 3.00AMP

Rating Current: 3.00AMP

接觸阻抗: 20mΩ Max

Contact Resistance: 20mΩ Max

絕緣阻抗: 1000MΩ Min

Insulating Resistance: 1000 MΩ Min

耐電壓: AC 500V/分鐘

Withstanding Voltage: AC 500V/Minute

溫度範圍: -40° C to +105° C

Temperture Range: -40° C to +105° C

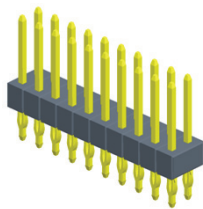

P125-12XXXXXXSXXX1
L=A+B+2.5

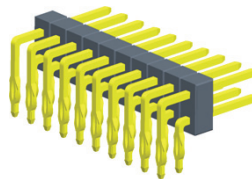

P125-12XXXXXRXXX1
L=A+B+D+3.75

Mating With/配對母座:
F135/F136/F145/F150/F157/F160
F168/F169/F170/F171/F175/F184
F185/F188/F111

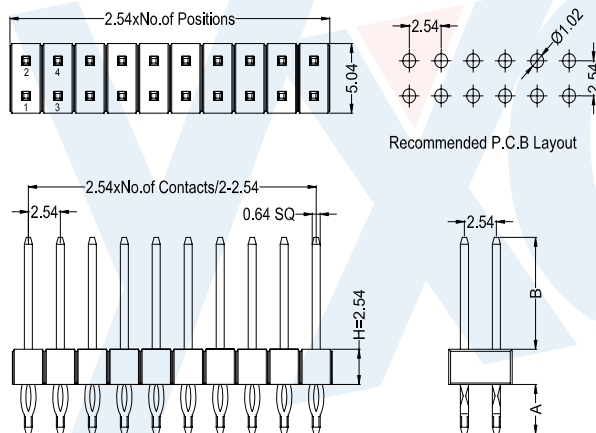
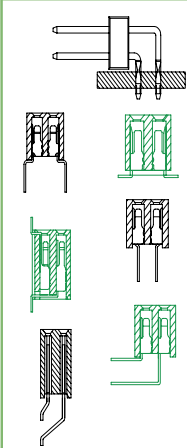

Dimension antitheses list		
ITEM	A	B
Standard	3.6	3.0/4.0/5.0/6.0
Alternate		

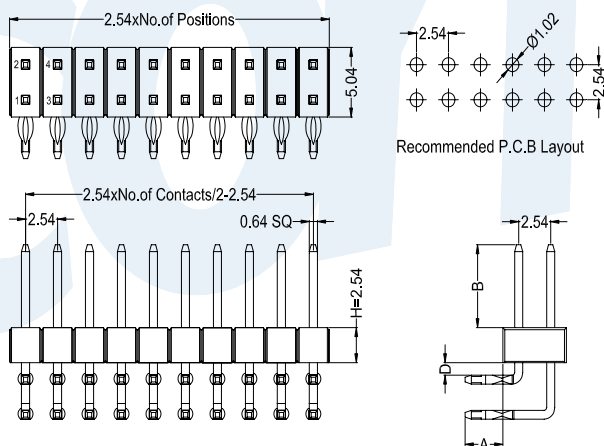

Dimension antitheses list			
ITEM	A	B	D
Standard	3.0	3.0/4.0/5.0/6.0	1.2
Alternate			

PIN HEADER

P 1 2 5 - 1 2

X X

X X

X

X

X X X

X

1

No. Of Pins Per Row
02~40P

Contact Plating
Full Of Gold A0=0.8u"
Semi-Gold B0=0.8u"

Insulator Material:
A: PBT
B: PA6T
C: PA9T
D: LCP

Contact Shape:
S: Straight
R: Right Angle

Length Of Terminal

Packing
A: PE Bag
B: Tape & Reel
C: Tube
D: Tube+CAP
E: Tray

A9=30u" B9=30U"
S1=Ordinary Tin Plated
S2=Matte Tin Plated
S3=Tin-plated High-temperature

[Http://www.yxcon.com](http://www.yxcon.com)

[E-mail:yx@yxcon.com](mailto:yx@yxcon.com)

YUXI DONGGUAN (東莞)
YUXI TAIWAN (台灣)

TEL:+86 769 85397456
TEL:+886 3313 2933

FAX:+86 769 85396015
FAX:+886 3313 2935

Specifications

備注 (Remark)

1. 材料 (Material)

膠芯: PA9T/LCP+30%G. F UL94V-0, 顏色: 黑色

Housing: PA9T/LCP+30%G. F UL94V-0, Color: Black

端子: 黃銅

Contact: Brass

2. 特性 (characteristics):

額定電流: 3.00AMP

Rating Current: 3.00AMP

接觸阻抗: 20mΩ Max

Contact Resistance: 20mΩ Max

絕緣阻抗: 1000MΩ Min

Insulating Resistance: 1000 MΩ Min

耐電壓: AC 500V/分钟

Withstanding Voltage: AC 500V/Minute

溫度範圍: -40° C to +105° C

Temperature Range: -40° C to +105° C

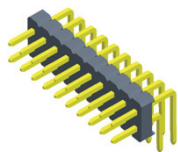

P125-12XXXXXXRXXXXX5

L=A+B+D+2.54*1.78

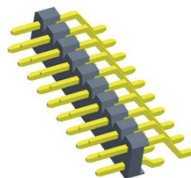

P125-12XXXXXXZXXXXX3

L=B+3.68*3.0

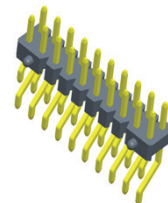

P125-12XXXXXXZXXXXX4

L=B+3.68*3.0

Mating With/配對母座:
F135/F136/F145/F150/F157/F160
F168/F169/F170/F171/F175/F184
F185/F186/F111

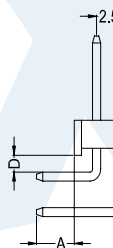
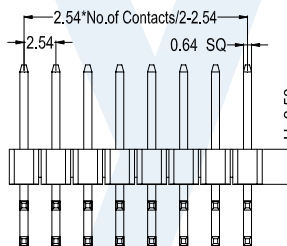
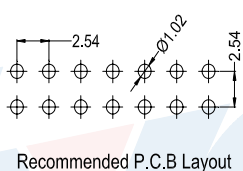
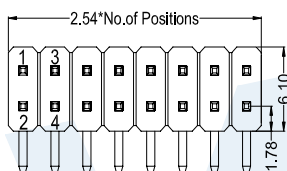
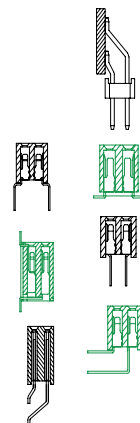

TYPE 5

Dimension antitheses list			
ITEM	A	B	D
Standard	3.0	3.0/4.0/5.0/6.0	1.2
Alternate			

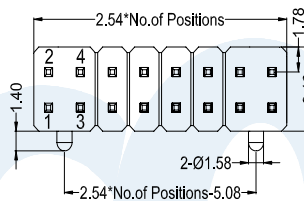

Recommended P.C.B Layout

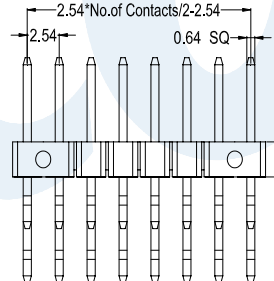

TYPE 3

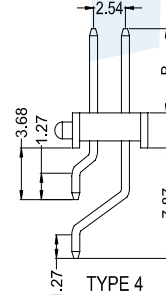

TYPE 4

Dimension antitheses list	
ITEM	B
Standard	3.0/4.0/5.0/6.0
Alternate	

P 1 2 5 - 1 2

X X

X X

X

X

X X X

X

X

No.Of Pins
Per Row
02~40P

Contact Plating
Full Of Gold A0=0.8u"
Semi-Gold B0=0.8U"
A9=30u" B9=30U"
S1=Ordinary Tin Plated
S2=Matte Tin Plated
S3=Tin-plated High-temperature

Insulator Material:
A:PBT
B:PA9T
C:PA9T
D:LCP

Contact Shape:
R:Right Angle
Z:90° SMT

Length Of
Terminal

Packing
A:PE Bag
B:Tape & Reel
C:Tube
D:Tube+CAP
E:Tray

Journal Number
3:Type3
4:Type4
5:Type5

[Http://www.yxcon.com](http://www.yxcon.com)

E-mail:yx@yxcon.com

YUXI DONGGUAN (東莞)
YUXI TAIWAN (台灣)

TEL:+86 769 85397456
TEL:+886 3313 2933

FAX:+86 769 85396015
FAX:+886 3313 2935

Specifications

備注 (Remark)

1. 材料 (Material)

膠芯: PA9T/LCP+30%G. F UL94V-0, 顏色: 黑色

Housing: PA9T/LCP+30%G. F UL94V-0, Color: Black

端子: 黃銅

Contact: Brass

2. 特性 (characteristics):

額定電流: 3.00AMP

Rating Current: 3.00AMP

接觸阻抗: 20mΩ Max

Contact Resistance: 20mΩ Max

絕緣阻抗: 1000MΩ Min

Insulating Resistance: 1000 MΩ Min

耐電壓: AC 500V/分鐘

Withstanding Voltage: AC 500V/Minute

溫度範圍: -40° C to +105° C

Temperature Range: -40° C to +105° C

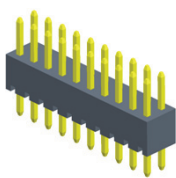

P143-12XXXXXSXXX1
L=A+B+4.3

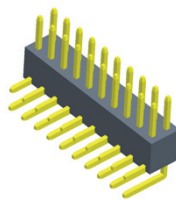

P143-12XXXXRXRXXX1
L=A+B+5.4

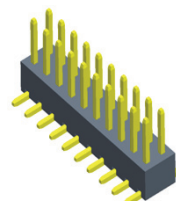

P143-12XXXXMXXX1
L=B+4.5+(W-2.54)/2



Mating With/配對母座:
F135/F136/F145/F150/F157/F160
F168/F169/F170/F171/F175/F184
F185/F186/F111

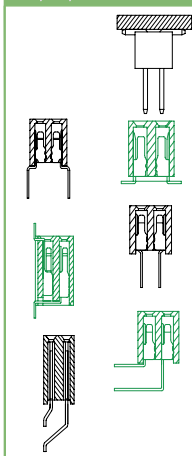

Dimension antheses list		
ITEM	A	B
Standard	3.00	3.0,4.0,5.0,6.0
Alternate		

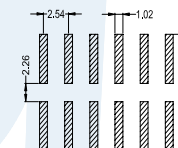
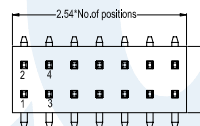
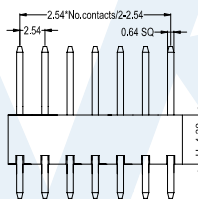
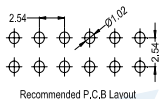
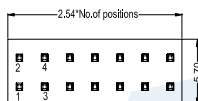

Recommended P.C.B Layout

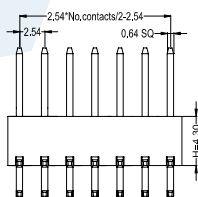
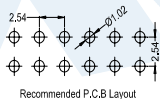
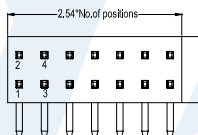

Dimension antheses list		
ITEM	A	B
Standard	3.00	3.0,4.0,5.0,6.0
Alternate		

Dimension antheses list		
ITEM	B	W
Standard	3.0,4.0,5.0,6.0	7.50
Alternate		

PIN HEADER

P 143 - 12

XX

XX

X

X

XXX

X

1

No.Of Pins Per Row
02~40P

Contact Plating
Full Of Gold A0=0.8u"
Semi-Gold B0=0.8u"
~
A9=30u" B9=30u"

Insulator Material:
A:PBT
B:PA6T
C:PA9T
D:LCP

Contact Shape:
S: Straight
R: Right Angle
M: SMT

Length Of Terminal

Packing
A: PE Bag
B: Tape & Reel
C: Tube
D: Tube+CAP
E: Tray

S1=Ordinary Tin Plated
S2=Matte Tin Plated
S3=Tin-plated High-temperature

[Http://www.yxcon.com](http://www.yxcon.com)

E-mail: yx@yxcon.com

YUXI DONGGUAN (東莞)
YUXI TAIWAN (台灣)

TEL:+86 769 85397456
TEL:+886 3313 2933

FAX:+86 769 85396015
FAX:+886 3313 2935

Specifications

備注 (Remark)

1. 材料 (Material)

膠芯: PA9T/LCP+30%G. F UL94V-0, 顏色: 黑色
Housing: PA9T/LCP+30%G. F UL94V-0, Color: Black
端子: 黃銅

Contact: Brass

2. 特性 (characteristics):

額定電流: 3.00AMP

Rating Current: 3.00AMP

接觸阻抗: 20mΩ Max

Contact Resistance: 20mΩ Max

絕緣阻抗: 1000MΩ Min

Insulating Resistance: 1000 MΩ Min

耐電壓: AC 500V/分钟

Withstanding Voltage: AC 500V/Minute

溫度範圍: -40° C to +105° C

Temperture Range: -40° C to +105° C

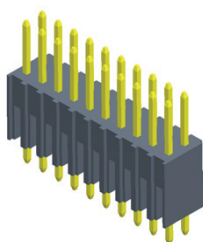

P174-12XXXXXSXXX1
L=A+B*7.4

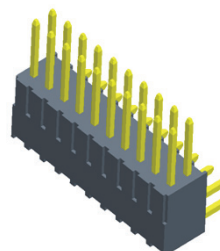

P174-12XXXXRXXX1
L=A+B*5.6

Mating With/配對母座:
F135/F136/F145/F150/F157/F160
F168/F169/F170/F171/F175/F184
F185/F186/F111

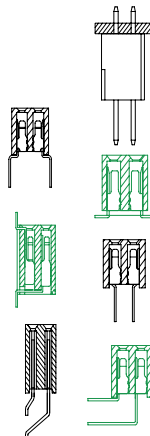

PIN HEADER

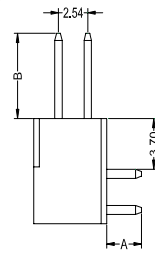
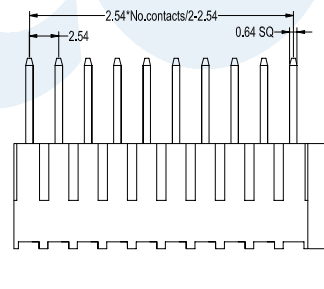
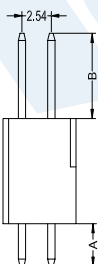
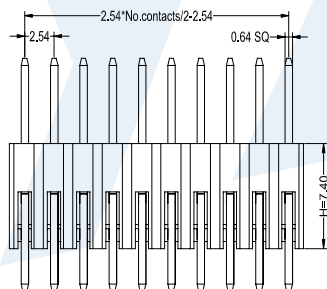
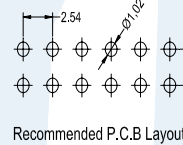
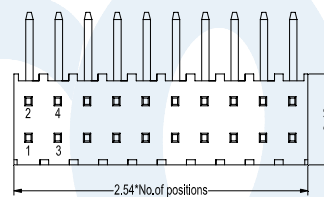
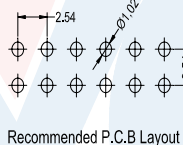
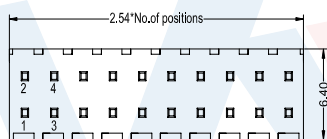

Dimension anitheses list		
ITEM	A	B
Standard	3.00	3.0/4.0/5.0/6.0
Alternate		

Dimension anitheses list		
ITEM	A	B
Standard	3.00	3.0/4.0/5.0/6.0
Alternate		

P 174 - 12

XX

XX

X

X

XXX

X

1

No.Of Pins Per Row
02~40P

Contact Plating
Full Of Gold
A0=0.8u"
~
A9=30u"
B0=0.8U"
~
B9=30U"

Insulator Material:
A:PBT
B:PA6T
C:PA9T
D:LCP

Contact Shape:
S: Straight
R: Right Angle

Length Of Terminal

Packing
A: PE Bag
B: Tape & Reel
C: Tube
D: Tube+CAP
E: Tray

S1=Ordinary Tin Plated
S2=Matte Tin Plated
S3=Tin-plated High-temperature

Http://www.yxcon.com

E-mail:yx@yxcon.com

YUXI DONGGUAN (東莞)
YUXI TAIWAN (台灣)

TEL:+86 769 85397456
TEL:+886 3313 2933

FAX:+86 769 85396015
FAX:+886 3313 2935