

**Specifications**

備注 (Remark)

1. 材料 (Material)

膠芯: PA9T/LCP+30% G. F UL94V-0, 顏色: 黑色  
Housing: PA9T/LCP+30% G. F UL94V-0, Color: Black  
端子: 磷銅

Contact: Phosphor Bronze

2. 特性 (characteristics):

額定電流: 2.0AMP  
Rating Current: 2.0AMP  
接觸阻抗: 20mΩ Max  
Contact Resistance: 20mΩ Max  
絕緣阻抗: 1000MΩ Min  
Insulating Resistance: 1000 MΩ Min  
耐電壓: AC 500V/分钟  
Withstanding Voltage: AC 500V/Minute  
溫度範圍: -55° C to +125° C  
Temperature Range: -55° C to +125° C

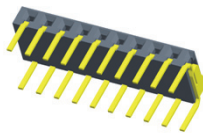

F219-11XXXXXRUX1

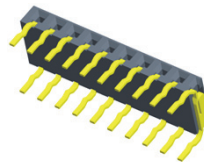

F219-11XXXXXRUX2

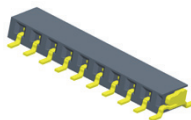

F219-11XXXXXMUX1

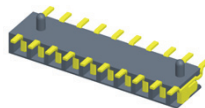

F219-11XXXXXMUX2

Mating With/配對公座:  
P210/P215/P220/P225/P227

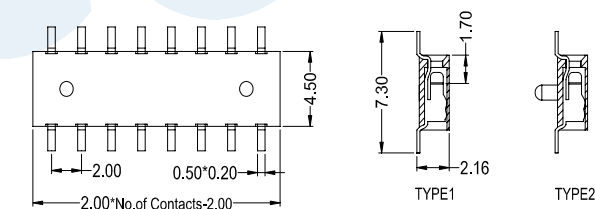
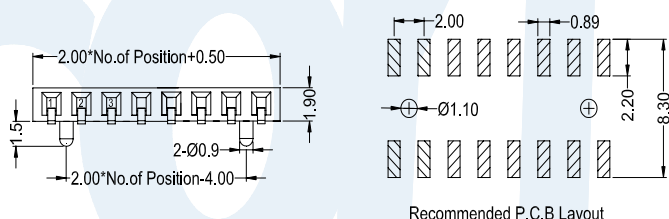
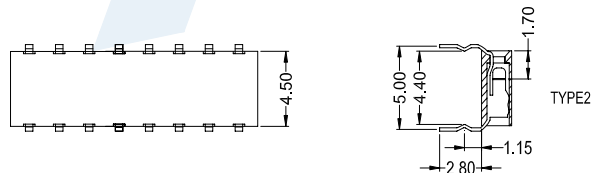
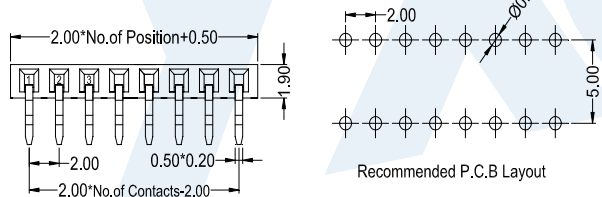
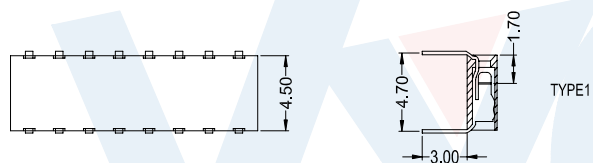
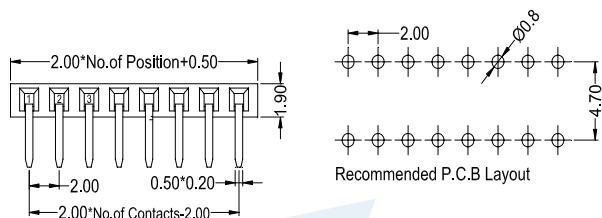
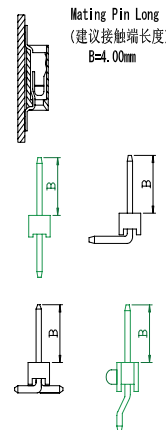

**F 219 - 11**

**XX**

**XX**

**X**

**X**

**U**

**X**

**X**

No. Of Pins Per Row  
02~40P

Contact Plating  
Full Of Gold A0=0.8u"  
Semi-Gold B0=0.8U"  
A9=30u" B9=30U"  
S1=Ordinary Tin Plated  
S2=Matte Tin Plated  
S3=Tin-plated High-temperature

Insulator Material:  
B: PA6T  
C: PA9T  
D: LCP

Contact Shape:  
R: Right Angle  
M: SMT

Packing  
A: PE Bag  
B: Tape & Reel  
C: Tube  
D: Tube+CAP  
E: Tray

Journal Number  
1: Type1  
2: Type2

## Specifications

備注 (Remark)

1. 材料 (Material)

膠芯: PA9T/LCP+30% G.F UL94V-0, 顏色: 黑色

Housing: PA9T/LCP+30% G.F UL94V-0, Color: Black

端子: 磷銅

Contact: Phosphor Bronze

2. 特性 (characteristics):

額定電流: 2.0AMP

Rating Current: 2.0AMP

接觸阻抗: 20mΩ Max

Contact Resistance: 20mΩ Max

絕緣阻抗: 1000MΩ Min

Insulating Resistance: 1000 MΩ Min

耐電壓: AC 500V/分鐘

Withstanding Voltage: AC 500V/Minute

溫度範圍: -55° C to +125° C

Temperture Range: -55° C to +125° C

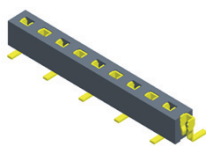

F220-11XXXXXMPX1

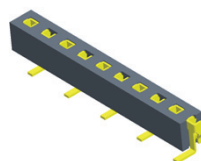

F220-11XXXXXMPX2



Mating With/配對公座:  
P210/P215/P220/P225/P227

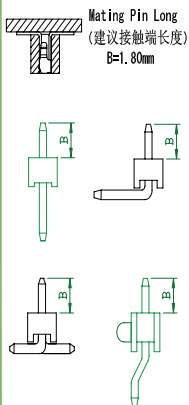

FEMALE HEADER

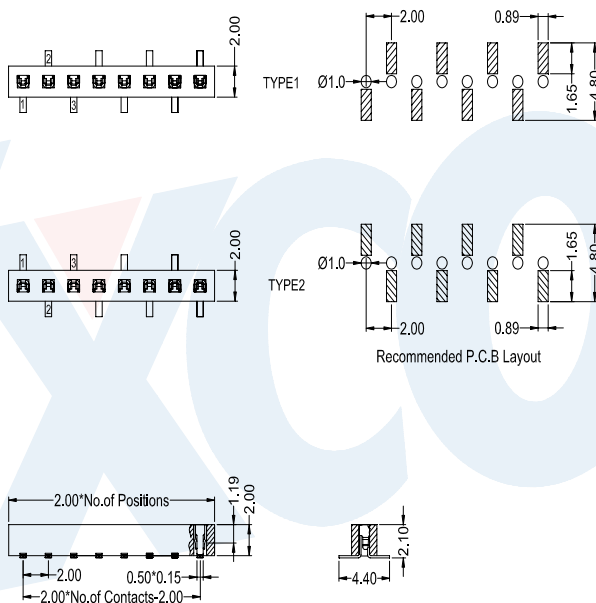

**F 2 2 0 - 1 1**

**X X**

**X X**

**X**

**M**

**P**

**X**

**X**

**No. Of Pins Per Row**  
02~40P

**Contact Plating**  
Full Of Gold A0=0.8u"  
Semi-Gold B0=0.8U"  
A9=30u" B9=30U"  
S1=Ordinary Tin Plated  
S2=Matte Tin Plated  
S3=Tin-plated High-temperature

**Insulator Material:**  
B: PA6T  
C: PA9T  
D: LCP

**Packing**  
A: PE Bag  
B: Tape & Reel  
C: Tube  
D: Tube+CAP  
E: Tray

**Journal Number**  
1: Type1  
2: Type2

Http://www.yxcon.com

E-mail: yx@yxcon.com

YUXI DONGGUAN (東莞)  
YUXI TAIWAN (台灣)

TEL: +86 769 85397456  
TEL: +886 3313 2933

FAX: +86 769 85396015  
FAX: +886 3313 2935

**Specifications**

備注 (Remark)

1. 材料 (Material)

膠芯: PA9T/LCP+30% G. F UL94V-0, 顏色: 黑色  
Housing: PA9T/LCP+30% G. F UL94V-0, Color: Black  
端子: 磷銅

Contact: Phosphor Bronze

2. 特性 (characteristics):

額定電流: 2.0AMP  
Rating Current: 2.0AMP  
接觸阻抗: 20mΩ Max  
Contact Resistance: 20mΩ Max  
絕緣阻抗: 1000MΩ Min  
Insulating Resistance: 1000 MΩ Min  
耐電壓: AC 500V/分鐘  
Withstanding Voltage: AC 500V/Minute  
溫度範圍: -55° C to +125° C  
Temperature Range: -55° C to +125° C

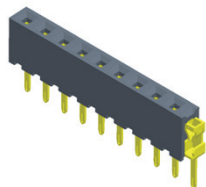

F221-11XXXXXSUX1

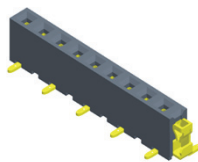

F221-11XXXXXMUX1  
F221-11XXXXXMUX3

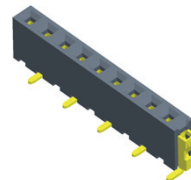

F221-11XXXXXMUX2  
F221-11XXXXXMUX4

Mating With/配對公座:  
P210/P215/P220/P225/P227

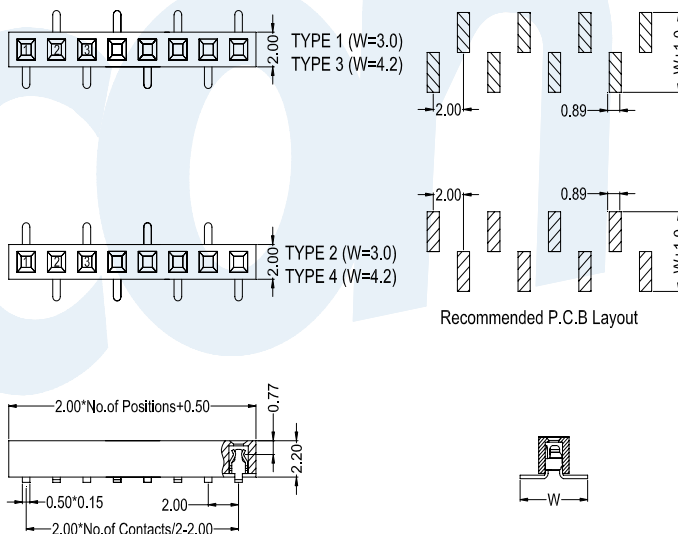
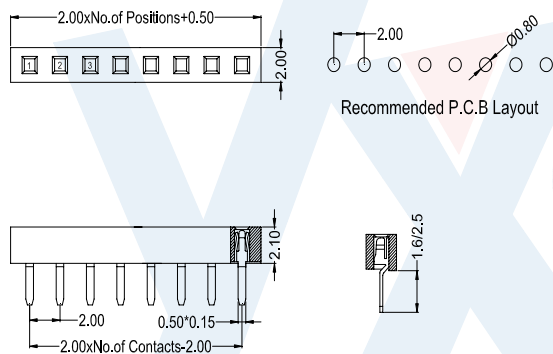
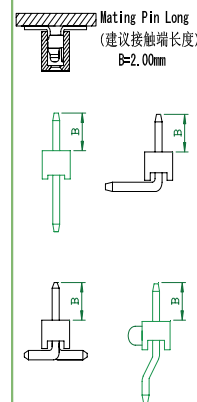

FEMALE HEADER

**F 2 2 1 - 1 1**

**X X**

**X X**

**X**

**X**

**U**

**X**

**X**

**No. Of Pins Per Row**  
02~40P

**Contact Plating**  
Full Of Gold A0=0.8u"  
Semi-Gold B0=0.8U"  
A9=30u" B9=30U"  
S1=Ordinary Tin Plated  
S2=Matte Tin Plated  
S3=Tin-plated High-temperature

**Insulator Material:**  
B: PA6T  
C: PA9T  
D: LCP

**Contact Shape:**  
S: Straight  
M: SMT

**Packing**  
A: PE Bag  
B: Tape & Reel  
C: Tube  
D: Tube+CAP  
E: Tray

**Journal Number**  
1: Type1  
2: Type2  
3: Type3  
4: Type4

## Specifications

備注 (Remark)

1. 材料 (Material)

膠芯: PA9T/LCP+30% G.F UL94V-0, 顏色: 黑色

Housing: PA9T/LCP+30% G.F UL94V-0, Color: Black

端子: 磷銅

Contact: Phosphor Bronze

2. 特性 (characteristics):

額定電流: 2.0AMP

Rating Current: 2.0AMP

接觸阻抗: 20mΩ Max

Contact Resistance: 20mΩ Max

絕緣阻抗: 1000MΩ Min

Insulating Resistance: 1000 MΩ Min

耐電壓: AC 500V/分鐘

Withstanding Voltage: AC 500V/Minute

溫度範圍: -55° C to +125° C

Temperture Range: -55° C to +125° C



Mating With/配對公座:  
P210/P215/P220/P225/P227

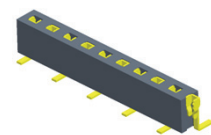
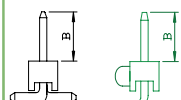
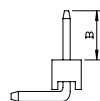

F227-11XXXXXMPX1

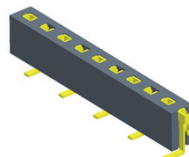

F227-11XXXXXMPX2

FEMALE HEADER

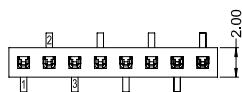

TYPE1

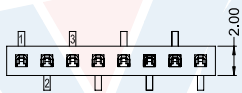
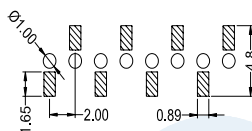

TYPE2

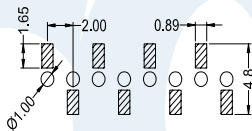

Recommended P.C.B Layout

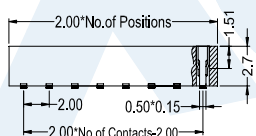

F 2 2 7 - 1 1

X X

X X

X

M

P

X

X

**No.Of Pins Per Row**  
02~40P

**Contact Plating**  
Full Of Gold A0=0.8u"  
Semi-Gold B0=0.8U"  
~  
A9=30u" B9=30U"  
S1=Ordinary Tin Plated  
S2=Matte Tin Plated  
S3=Tin-plated High-temperature

**Insulator Material:**  
B:PA6T  
C:PA9T  
D:LCP

**Packing**  
A:PE Bag  
B:Tape & Reel  
C:Tube  
D:Tube+CAP  
E:Tray

**Journal Number**  
1:Type1  
2:Type2

**Specifications**

備注 (Remark)

1. 材料 (Material)

膠芯: PA9T/LCP+30% G. F UL94V-0, 顏色: 黑色  
Housing: PA9T/LCP+30% G. F UL94V-0, Color: Black  
端子: 磷銅

Contact: Phosphor Bronze

2. 特性 (characteristics):

額定電流: 2.0AMP  
Rating Current: 2.0AMP  
接觸阻抗: 20mΩ Max  
Contact Resistance: 20mΩ Max  
絕緣阻抗: 1000MΩ Min  
Insulating Resistance: 1000 MΩ Min  
耐電壓: AC 500V/分鐘  
Withstanding Voltage: AC 500V/Minute  
溫度範圍: -55° C to +125° C  
Temperature Range: -55° C to +125° C

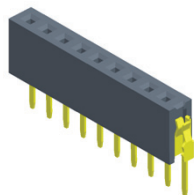

F228-11XXXXXSUX1

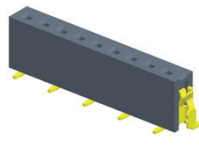

F228-11XXXXXMUX1

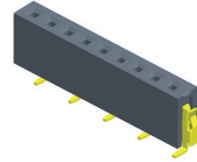

F228-11XXXXXMUX2

Mating With/配對公座:  
P210/P215/P220/P225/P227

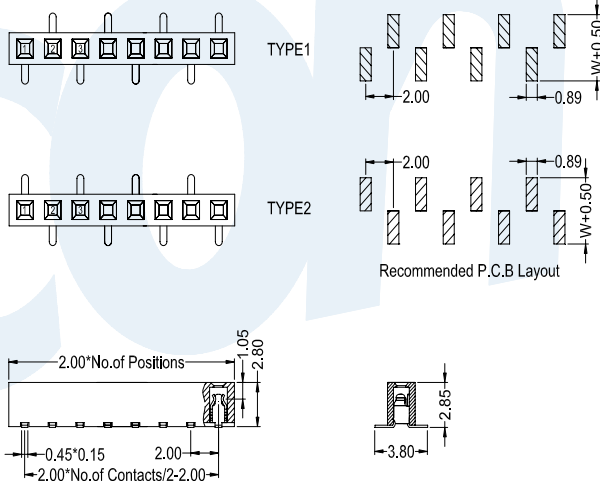
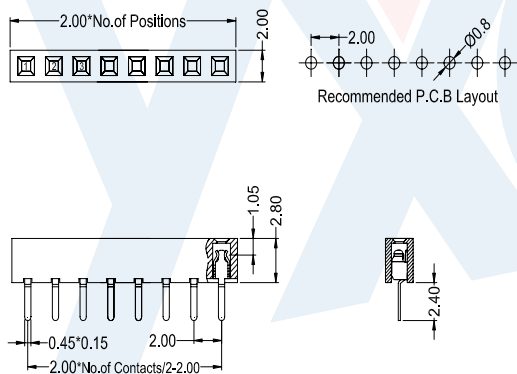
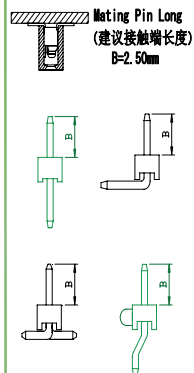

FEMALE HEADER

F 2 2 8 - 1 1

X X

X X

X

X

U

X

X

No. Of Pins Per Row  
02~40P

Contact Plating  
Full Of Gold A0=0.8u"  
Semi-Gold B0=0.8U"  
A9=30u" B9=30U"  
S1=Ordinary Tin Plated  
S2=Matte Tin Plated  
S3=Tin-plated High-temperature

Insulator Material:  
B: PA6T  
C: PA9T  
D: LCP

Contact Shape:  
S: Straight  
M: SMT

Packing  
A: PE Bag  
B: Tape & Reel  
C: Tube  
D: Tube+CAP  
E: Tray

Journal Number  
1: Type1  
2: Type2

## Specifications

備注 (Remark)

1. 材料 (Material)

膠芯: PA9T/LCP+30% G.F UL94V-0, 顏色: 黑色

Housing: PA9T/LCP+30% G.F UL94V-0, Color: Black

端子: 磷銅

Contact: Phosphor Bronze

2. 特性 (characteristics):

額定電流: 2.0AMP

Rating Current: 2.0AMP

接觸阻抗: 20mΩ Max

Contact Resistance: 20mΩ Max

絕緣阻抗: 1000MΩ Min

Insulating Resistance: 1000 MΩ Min

耐電壓: AC 500V/分钟

Withstanding Voltage: AC 500V/Minute

溫度範圍: -55° C to +125° C

Temperature Range: -55° C to +125° C

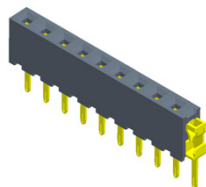

F235-11XXXXXSUX1

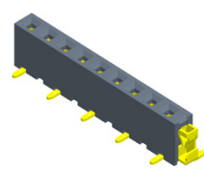

F235-11XXXXXMUX1

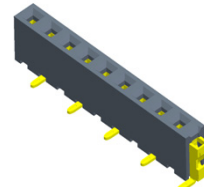

F235-11XXXXXMUX2

Mating With/ 配對公座:  
P210/P215/P220/P225/P227



Mating Pin Long  
(建議接觸端長度)  
B=3.00mm

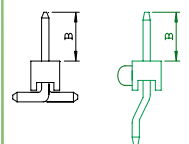
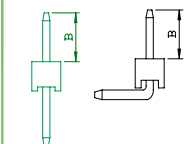

FEMALE HEADER

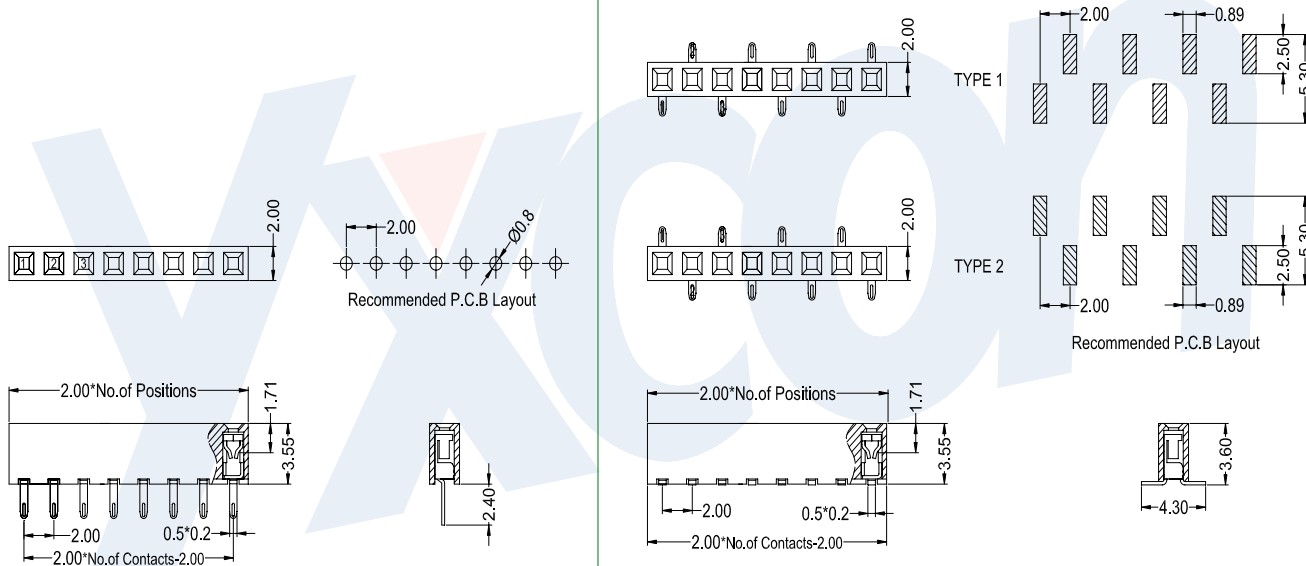

<b>F 2 3 5 - 1 1</b>	<b>X X</b>	<b>X X</b>	<b>X</b>	<b>X</b>	<b>U</b>	<b>X</b>	<b>X</b>
<b>No. Of Pins Per Row</b> 02~40P		<b>Contact Plating</b> Full Of Gold A0=0.8u" Semi-Gold B0=0.8U" ~ A9=30u" B9=30U" S1=Ordinary Tin Plated S2=Matte Tin Plated S3=Tin-plated High-temperature	<b>Insulator Material:</b> B:PA6T C:PA9T D:LCP	<b>Contact Shape:</b> S: Straight M: SMT		<b>Packing</b> A: PE Bag B: Tape & Reel C: Tube D: Tube+CAP E: Tray	<b>Journal Number</b> 1: Type1 2: Type2

[Http://www.yxcon.com](http://www.yxcon.com) [E-mail:yx@yxcon.com](mailto:yx@yxcon.com)

YUXI DONGGUAN (東莞) TEL:+86 769 85397456 FAX:+86 769 85396015  
YUXI TAIWAN (台灣) TEL:+886 3313 2933 FAX:+886 3313 2935

**Specifications**

備注 (Remark)

1. 材料 (Material)

膠芯: PA9T/LCP+30% G. F UL94V-0, 顏色: 黑色  
 Housing: PA9T/LCP+30% G. F UL94V-0, Color: Black  
 端子: 磷銅

Contact: Phosphor Bronze

2. 特性 (characteristics):

額定電流: 2.0AMP  
 Rating Current: 2.0AMP  
 接觸阻抗: 20mΩ Max  
 Contact Resistance: 20mΩ Max  
 絕緣阻抗: 1000MΩ Min  
 Insulating Resistance: 1000 MΩ Min  
 耐電壓: AC 500V/分鐘  
 Withstanding Voltage: AC 500V/Minute  
 溫度範圍: -55° C to +125° C  
 Temperature Range: -55° C to +125° C

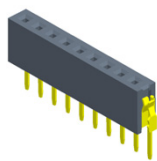

F240-11XXXXXSUX1  
 F243-11XXXXXSUX1  
 F246-11XXXXXSUX1

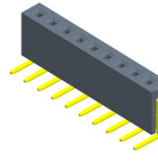

F240-11XXXXXRUX1  
 F243-11XXXXXRUX1  
 F246-11XXXXXRUX1

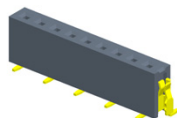

F240-11XXXXXMUX1  
 F243-11XXXXXMUX1  
 F246-11XXXXXMUX1

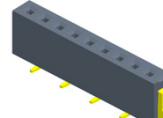

F240-11XXXXMUX2  
 F243-11XXXXMUX2  
 F246-11XXXXMUX2

Mating With/配對公座:  
 P210/P215/P220/P225/P227

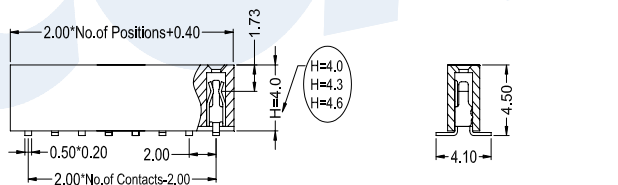
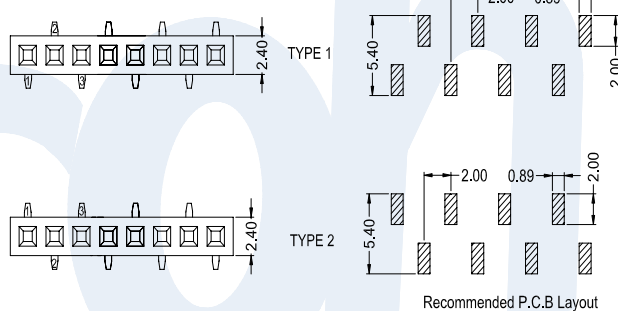
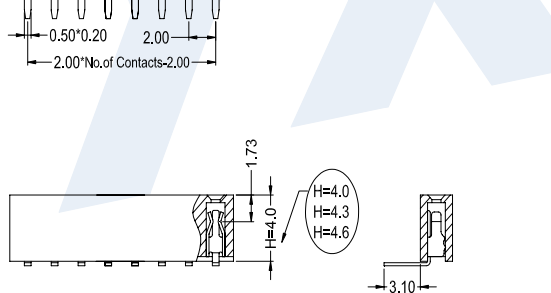
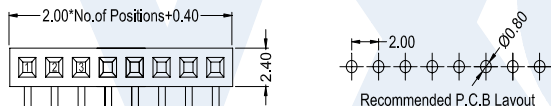
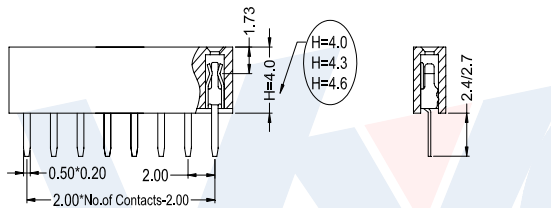
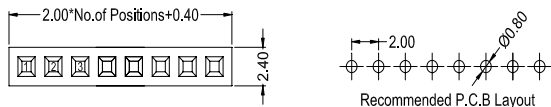
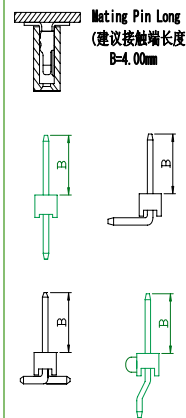

FEMALE HEADER

<b>F 2 4 0 - 1 1</b>	<b>XX</b>	<b>XX</b>	<b>X</b>	<b>X</b>	<b>U</b>	<b>X</b>	<b>X</b>				
<b>F 2 4 3 - 1 1</b>											
<b>F 2 4 6 - 1 1</b>											
<b>No. Of Pins Per Row</b>	02~40P	<b>Contact Plating</b>	Full Of Gold A0=0.8u" ~ A9=30u" S1=Ordinary Tin Plated S2=Matte Tin Plated S3=Tin-plated High-temperature	<b>Insulator Material:</b>	B:PA6T C:PA9T D:LCP	<b>Contact Shape:</b>	S: Straight R: Right Angle M: SMT	<b>Packing</b>	A: PE Bag B: Tape & Reel C: Tube D: Tube+CAP E: Tray	<b>Journal Number</b>	1: Type1 2: Type2

**Specifications**

備注 (Remark)

1. 材料 (Material)

膠芯: PA9T/LCP+30% G.F UL94V-0, 顏色: 黑色

Housing: PA9T/LCP+30% G.F UL94V-0, Color: Black

端子: 磷銅

Contact: Phosphor Bronze

2. 特性 (characteristics):

額定電流: 2.0AMP

Rating Current: 2.0AMP

接觸阻抗: 20mΩ Max

Contact Resistance: 20mΩ Max

絕緣阻抗: 1000MΩ Min

Insulating Resistance: 1000 MΩ Min

耐電壓: AC 500V/分钟

Withstanding Voltage: AC 500V/Minute

溫度範圍: -55° C to +125° C

Temperture Range: -55° C to +125° C

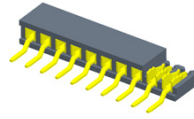

F243-11XXXXXZUX1

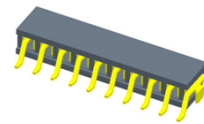

F243-11XXXXXZUX2

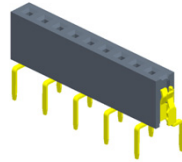

F243-11XXXXXWUX1

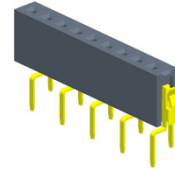

F243-11XXXXXWUX2

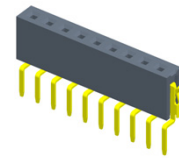

F243-11XXXXXWUX3

Mating With/配對公差:  
P210/P215/P220/P225/P227

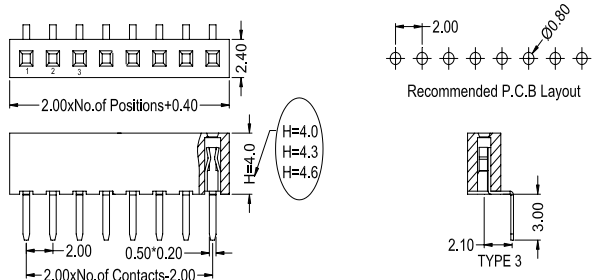
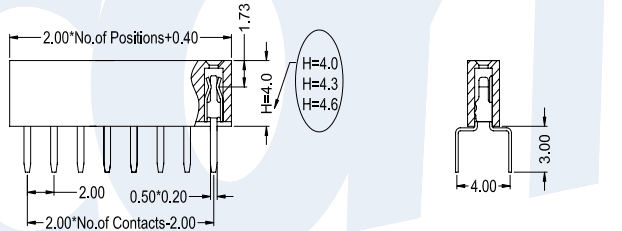
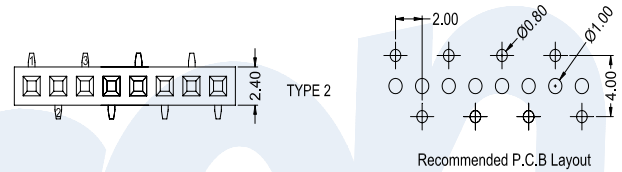
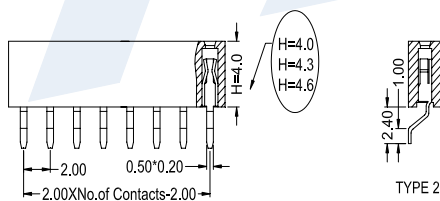
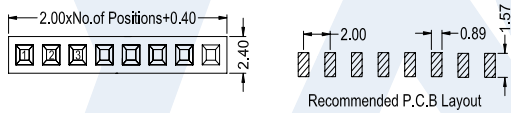
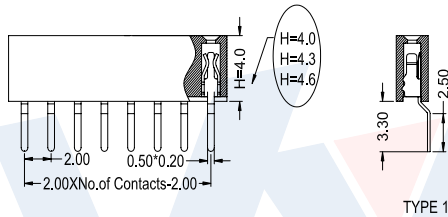
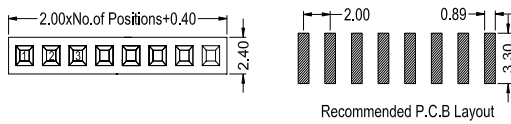
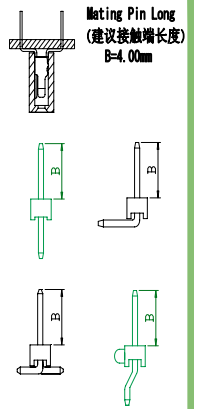

F 2 4 0 - 1 1  
 F 2 4 3 - 1 1  
 F 2 4 6 - 1 1

XX

No.Of Pins  
Per Row  
02~40P

XX

Contact Plating  
Full Of Gold A0=0.8u"  
Semi-Gold B0=0.8U"  
A9=30u" B9=30U"  
S1=Ordinary Tin Plated  
S2=Matte Tin Plated  
S3=Tin-plated High-temperature

X

Insulator Material:  
B:PA6T  
C:PA9T  
D:LCP

X

Contact Shape:  
W:Bottom Entry  
Z:90° SMT

U

Packing  
A:PE Bag  
B:Tape & Reel  
C:Tube  
D:Tube+CAP  
E:Tray

X

Journal Number  
1:Type1  
2:Type2  
3:Type3

X



## Specifications

備注 (Remark)

1. 材料 (Material)

膠芯: PA9T/LCP+30% G. F UL94V-0, 顏色: 黑色

Housing: PA9T/LCP+30% G. F UL94V-0, Color: Black

端子: 磷銅

Contact: Phosphor Bronze

2. 特性 (characteristics):

額定電流: 2.0AMP

Rating Current: 2.0AMP

接觸阻抗: 20mΩ Max

Contact Resistance: 20mΩ Max

絕緣阻抗: 1000MΩ Min

Insulating Resistance: 1000 MΩ Min

耐電壓: AC 500V/分鐘

Withstanding Voltage: AC 500V/Minute

溫度範圍: -55° C to +125° C

Temperature Range: -55° C to +125° C

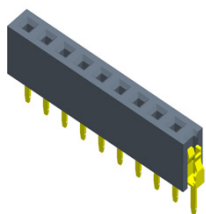

F240-11XXXXXSFX1

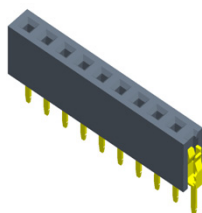

F243-11XXXXXSFX1

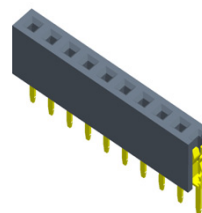

F246-11XXXXXSFX1

Mating With/ 配對公座:  
 P210/P215/P220/P225/P227

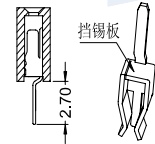
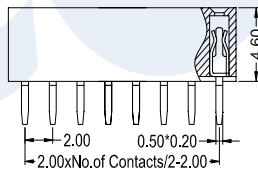
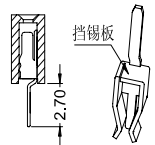
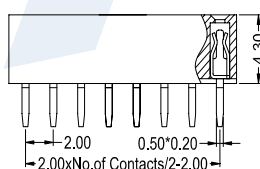
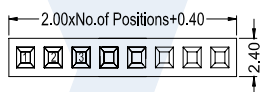
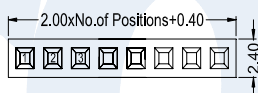
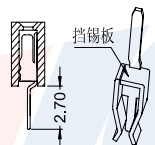
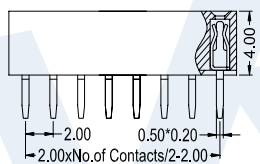
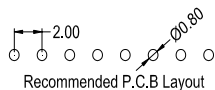
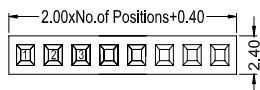
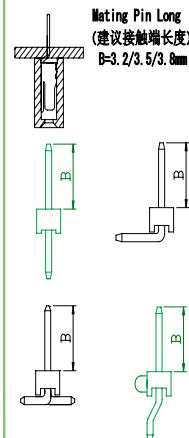

FEMALE HEADER

<b>F 2 4 0 - 1 1</b>	<b>XX</b>	<b>XX</b>	<b>X</b>	<b>S</b>	<b>F</b>	<b>X</b>	<b>1</b>
<b>F 2 4 3 - 1 1</b>	<b>No. Of Pins Per Row</b> 02-40P	<b>Contact Plating</b> Full Of Gold A0=0.8u" Semi-Gold B0=0.8U" ~ A9=30u" B9=30U" S1=Ordinary Tin Plated S2=Matte Tin Plated S3=Tin-plated High-temperature	<b>Insulator Material:</b> B:PA6T C:PA9T D:LCP			<b>Packing</b> A:PE Bag B:Tape & Reel C:Tape D:Tape+CAP E:Tray	
<b>F 2 4 6 - 1 1</b>							

**Specifications**

備注 (Remark)

1. 材料 (Material)

膠芯: PA9T/LCP+30% G.F UL94V-0, 顏色: 黑色

Housing: PA9T/LCP+30% G.F UL94V-0, Color: Black

端子: 磷銅

Contact: Phosphor Bronze

2. 特性 (characteristics):

額定電流: 2.0AMP

Rating Current: 2.0AMP

接觸阻抗: 20mΩ Max

Contact Resistance: 20mΩ Max

絕緣阻抗: 1000MΩ Min

Insulating Resistance: 1000 MΩ Min

耐電壓: AC 500V/分钟

Withstanding Voltage: AC 500V/Minute

溫度範圍: -55° C to +125° C

Temperture Range: -55° C to +125° C

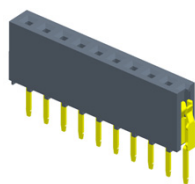

F255-11XXXXXSUX1

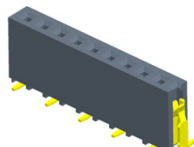

F255-11XXXXXMUX1

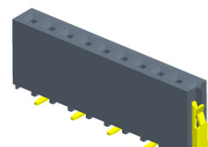

F255-11XXXXXMUX2



Mating With/配對公座:  
P210/P215/P220/P225/P227

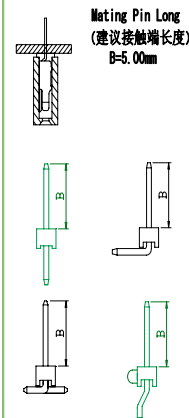

FEMALE HEADER

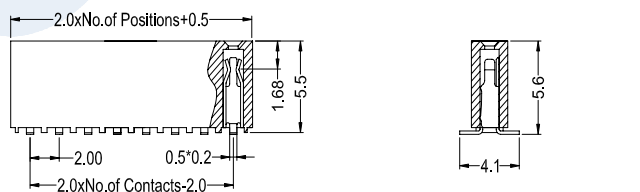
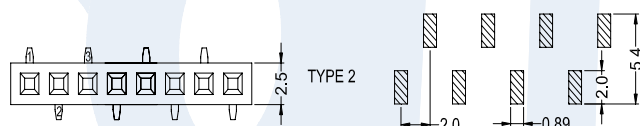
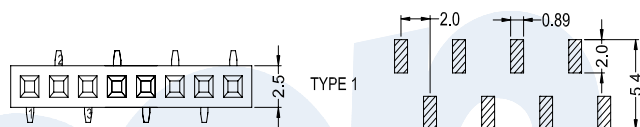
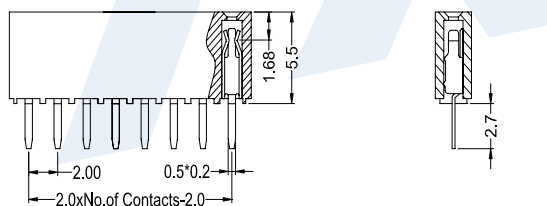
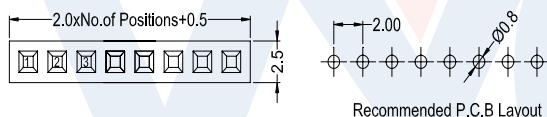

**F 2 5 5 - 1 1**

**XX**

**XX**

**X**

**X**

**U**

**X**

**X**

No.Of Pins Per Row  
02~40P

Contact Plating  
Full Of Gold A0=0.8u"  
Semi-Gold B0=0.8U"

Insulator Material:  
B:PA6T  
C:PA9T  
D:LCP

Contact Shape:  
S: Straight  
M: SMT

Packing  
A: PE Bag  
B: Tape & Reel  
C: Tube  
D: Tube+CAP  
E: Tray

Journal Number  
1: Type1  
2: Type2

A9=30u" B9=30U"  
S1=Ordinary Tin Plated  
S2=Matte Tin Plated  
S3=Tin-plated High-temperature

Http://www.yxcon.com

E-mail:yx@yxcon.com

YUXI DONGGUAN (東莞)  
YUXI TAIWAN (台灣)

TEL:+86 769 85397456  
TEL:+886 3313 2933

FAX:+86 769 85396015  
FAX:+886 3313 2935

## Specifications

備注 (Remark)

1. 材料 (Material)

膠芯: PA9T/LCP+30% G. F UL94V-0, 顏色: 黑色

Housing: PA9T/LCP+30% G. F UL94V-0, Color: Black

端子: 磷銅

Contact: Phosphor Bronze

2. 特性 (characteristics):

額定電流: 2.0AMP

Rating Current: 2.0AMP

接觸阻抗: 20mΩ Max

Contact Resistance: 20mΩ Max

絕緣阻抗: 1000MΩ Min

Insulating Resistance: 1000 MΩ Min

耐電壓: AC 500V/分鐘

Withstanding Voltage: AC 500V/Minute

溫度範圍: -55° C to +125° C

Temperature Range: -55° C to +125° C

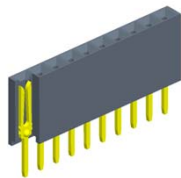

F263-11XXXXXSXY1

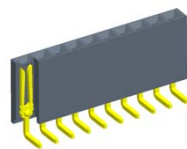

F263-11XXXXXRYX1

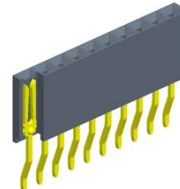

F263-11XXXXXZYX1

Mating With/配對公座:  
P210/P215/P220/P225/P227

Mating Pin Long  
(建議接觸端長度)  
B=1.00mm

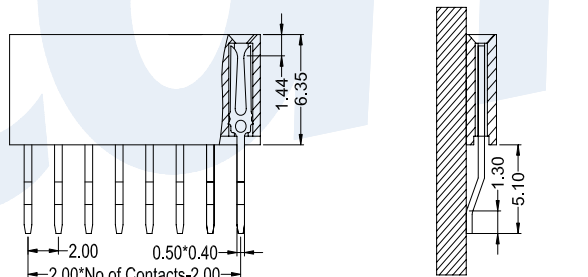
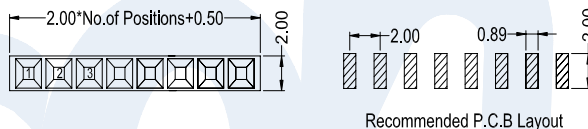
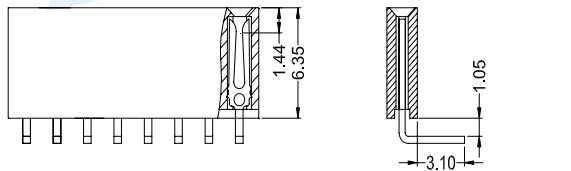
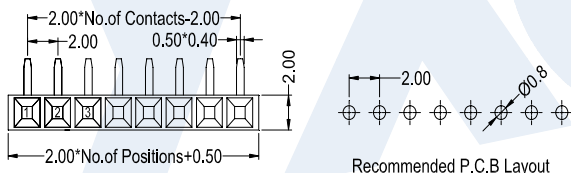
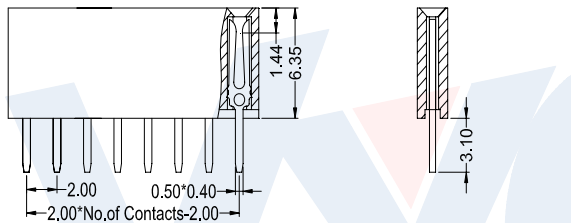
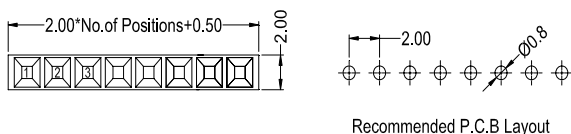
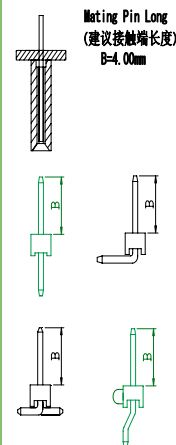

FEMALE HEADER

**F 2 6 3 - 1 1**

**X X**

**X X**

**X**

**X**

**Y**

**X**

**1**

**No.Of Pins Per Row**  
02-40P

**Contact Plating**  
Full Of Gold A0=0.8u"  
Semi-Gold B0=0.8u"

**Insulator Material:**  
B:PA6T  
C:PA9T  
D:LCP

**Contact Shape:**  
S: Straight  
R: Right Angle  
Z: 90° SMT

**Packing**  
A: PE Bag  
B: Tape & Reel  
C: Tube  
D: Tube+CAP  
E: Tray

A9=30u" B9=30U"  
S1=Ordinary Tin Plated  
S2=Matte Tin Plated  
S3=Tin-plated High-temperature

## Specifications

備注 (Remark)

1. 材料 (Material)

膠芯: PA9T/LCP+30% G.F UL94V-0, 顏色: 黑色

Housing: PA9T/LCP+30% G.F UL94V-0, Color: Black

端子: 磷銅

Contact: Phosphor Bronze

2. 特性 (characteristics):

額定電流: 2.0AMP

Rating Current: 2.0AMP

接觸阻抗: 20mΩ Max

Contact Resistance: 20mΩ Max

絕緣阻抗: 1000MΩ Min

Insulating Resistance: 1000 MΩ Min

耐電壓: AC 500V/分鐘

Withstanding Voltage: AC 500V/Minute

溫度範圍: -55° C to +125° C

Temperature Range: -55° C to +125° C

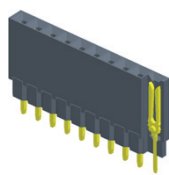

F271-21XXXXSYX1

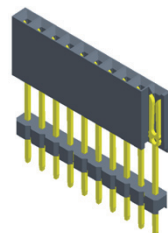

F263-21XXXXSYX1

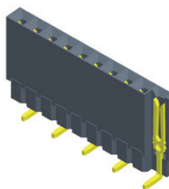

F271-21XXXXMYX1

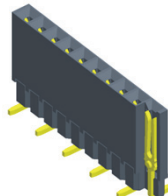

F271-21XXXXMYX2

Mating With/配對公座:  
P210/P215/P220/P225/P227

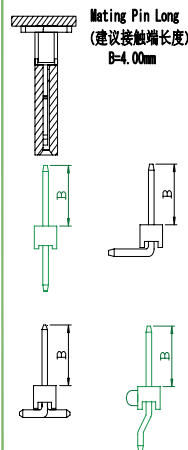

FEMALE HEADER

PART NO	DIM "H"	DIM "L"
F271-21XXXXBSYE1	1.00	7.00
F276-21XXXXBSYE1	1.50	7.60
F281-21XXXXBSYE1	2.00	8.10

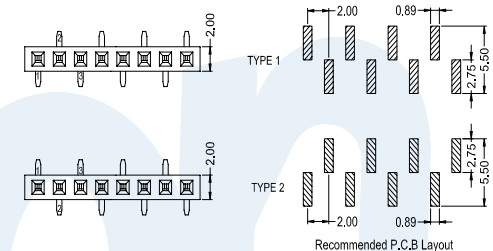
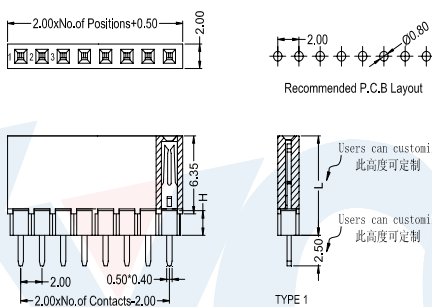

PART NO	DIM "L"	DIM "H"
F263-21XXXXSYX1	8.35	1.00
F263-21XXXXSYX2	9.35	1.50
F263-21XXXXSYX3	19.30	2.00

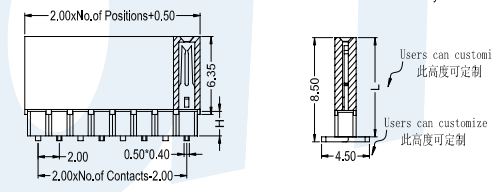
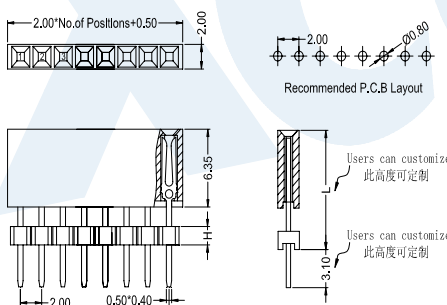

PART NO	DIM "H"	DIM "L"
F271-11XXXXMYX1	1.00	7.00
F271-11XXXXMYX2	1.00	7.00
F276-11XXXXMYX1	1.50	7.60
F276-11XXXXMYX2	1.50	7.60
F281-11XXXXMYX1	2.00	8.10
F281-11XXXXMYX2	2.00	8.10

**F 2 6 3 - 2 1**  
**F 2 7 1 - 2 1**  
**F 2 7 6 - 2 1**  
**F 2 8 1 - 2 1**

**XX**  
No. Of Pins  
Per Row  
02~40P

**XX**  
Contact Plating  
Full Of Gold A0=0.8u"  
Semi-Gold B0=0.8U"  
A9=30u" B9=30U"  
S1=Ordinary Tin Plated  
S2=Matte Tin Plated  
S3=Tin-plated High-temperature

**X**  
Insulator Material:  
B: PA6T  
C: PA9T  
D: LCP

**X**  
Contact Shape:  
S: Straight  
M: SMT

**Y**  
Packing  
A: PE Bag  
B: Tape & Reel  
C: Tube  
D: Tube+CAP  
E: Tray

**X**  
Journal Number  
1: Type1  
2: Type2  
3: Type3