

Specifications

備注 (Remark)

1. 材料 (Material)

膠芯: PA9T/LCP+30%G. F UL94V-0, 顏色: 黑色

Housing: PA9T/LCP+30%G. F UL94V-0, Color: Black

端子: 黃銅

Contact: Brass

2. 特性 (characteristics):

絕緣電阻: 3.00AMP

Rating Current: 3.00AMP

接觸阻抗: 20mΩ Max

Contact Resistance: 20mΩ Max

絕緣阻抗: 1000MΩ Min

Insulating Resistance: 1000 MΩ Min

耐電壓: AC 500V/分鐘

Withstanding Voltage: AC 500V/Minute

溫度範圍: -40° C to +105° C

Temperature Range: -40° C to +105° C

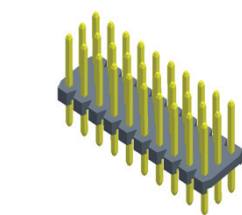

P125-13XXXXXSXXX1
L=A+B+2.5

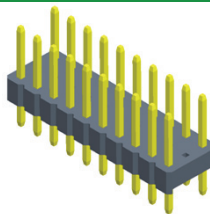

P125-13XXXXXSXXX2
L=A+B+2.5

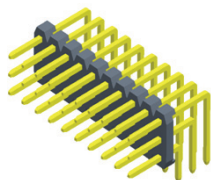

P125-13XXXXRXXXX1
L=A+B+D+3.75

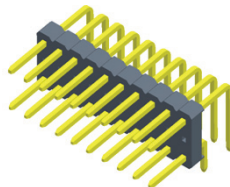

P125-13XXXXRXXXX2
L=A+B+D+3.75

Mating With/配對母座:
F150/F171/F185

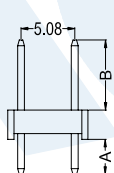
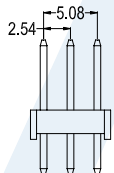
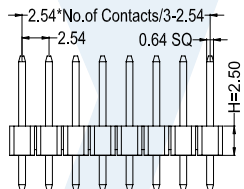
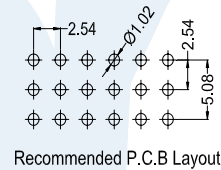
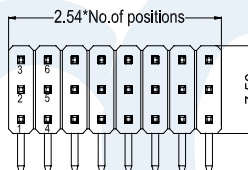
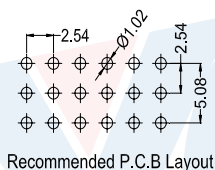
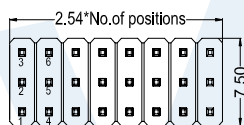
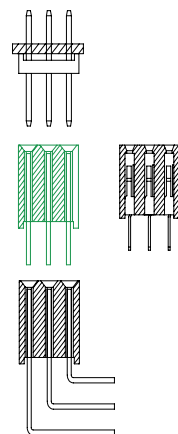

TYPE 1

TYPE 2

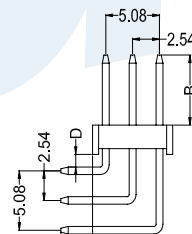
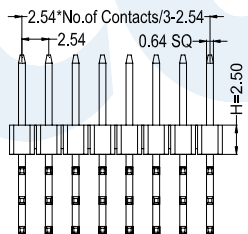

TYPE 1

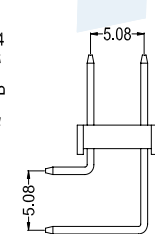

TYPE 2

Dimension antitheses list		
ITEM	A	B
Standard	3.00	4.5/6.0
Alternate		

Dimension antitheses list			
ITEM	A	B	D
Standard	3.00	4.5/6.0	1.20
Alternate			

P 1 2 5 - 1 3

XX

XX

X

X

XXX

X

X

No.Of Pins Per Row
02~40P

Contact Plating
Full Of Gold Semi-Gold
A0=0.8u" B0=0.8U"
~ ~
A9=30u" B9=30U"
S1=Ordinary Tin Plated
S2=Matte Tin Plated
S3=Tin-plated High-temperature

Insulator Material:
A:PBT
B:PA6T
C:PA9T
D:LCP

Contact Shape:
S: Straight
R: Right Angle

Length Of Terminal

Packing
A: PE Bag
B: Tape & Reel
C: Tube
D: Tube+CAP
E: Tray

Journal Number
1: Type1
2: Type2

Specifications

備注 (Remark)

1. 材料 (Material)

膠芯: PA9T/LCP+30%G. F UL94V-0, 顏色: 黑色

Housing: PA9T/LCP+30%G. F UL94V-0, Color: Black

端子: 黃銅

Contact: Brass

2. 特性 (characteristics):

額定電流: 3.00AMP

Rating Current: 3.00AMP

接觸阻抗: 20mΩ Max

Contact Resistance: 20mΩ Max

絕緣阻抗: 1000MΩ Min

Insulating Resistance: 1000 MΩ Min

耐電壓: AC 500V/分鐘

Withstanding Voltage: AC 500V/Minute

溫度範圍: -40° C to +105° C

Temperture Range: -40° C to +105° C

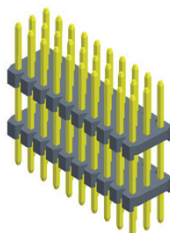

P125-23XXXXXX1

L=A+B+C

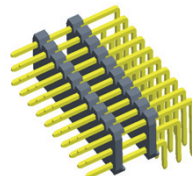

P125-23XXXXXX1

L=A+B+C+D+1.25

Mating With/配對母座:
F150/F171/F185

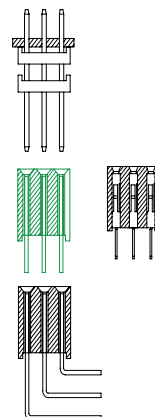

PIN HEADER

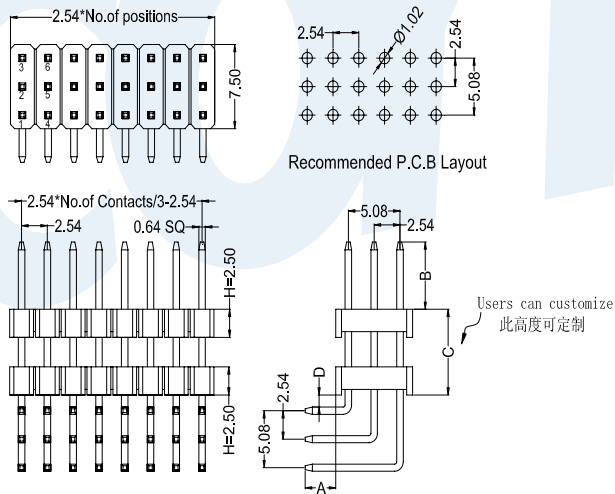
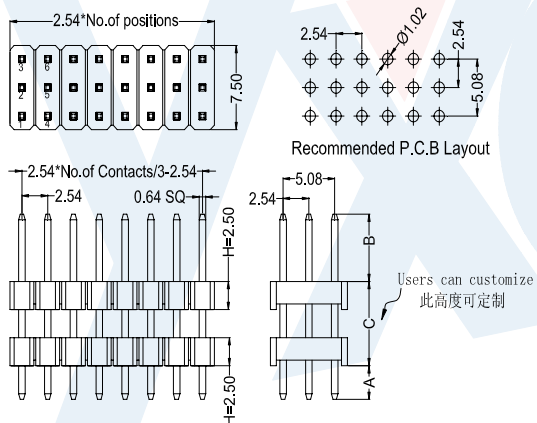

Dimension antitheses list			
ITEM	A	B	C
Standard	3.00	4.5/6.0	
Alternate			

Dimension antitheses list				
ITEM	A	B	C	D
Standard	3.00	4.5/6.0		1.20
Alternate				

P 125 - 2 3

XX

XX

X

X

XXX

X

1

No. Of Pins Per Row
02~40P

Contact Plating
Full Of Gold
A0=0.8u"
~
A9=30u"
S1=Ordinary Tin Plated
S2=Matte Tin Plated
S3=Tin-plated High-temperature

Insulator Material:
A: PBT
B: PA6T
C: PA9T
D: LCP

Contact Shape:
S: Straight
R: Right Angle

Length Of Terminal

Packing
A: PE Bag
B: Tape & Reel
C: Tube
D: Tube+CAP
E: Tray

Http://www.yxcon.com

E-mail:yx@yxcon.com

YUXI DONGGUAN (東莞)
YUXI TAIWAN (台灣)

TEL:+86 769 85397456
TEL:+886 3313 2933

FAX:+86 769 85396015
FAX:+886 3313 2935