

Specifications

備注 (Remark)

1. 材料 (Material)

膠芯: PA9T/LCP+30%G. F UL94V-0, 顏色: 黑色

Housing: PA9T/LCP+30%G. F UL94V-0, Color: Black

端子: 黃銅

Contact: Brass

2. 特性 (characteristics):

額定電流: 3.00AMP

Rating Current: 3.00AMP

接觸阻抗: 20mΩ Max

Contact Resistance: 20mΩ Max

絕緣阻抗: 1000MΩ Min

Insulating Resistance: 1000 MΩ Min

耐電壓: AC 500V/分鐘

Withstanding Voltage: AC 500V/Minute

溫度範圍: -40° C to +105° C

Temperature Range: -40° C to +105° C

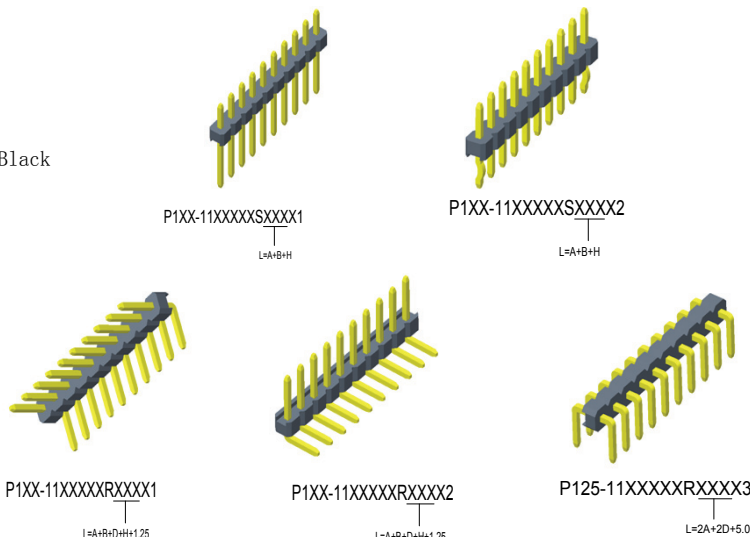

Mating With/配對母座:

F134/F135/F136/F145/F150/F157
F160/F168/F169/F171/F175/F184
F185/F186/F111

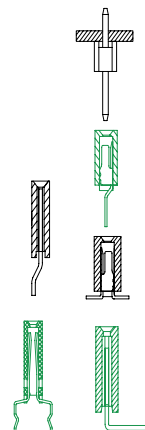

Dimension antitheses list				
ITEM	A	B	H	
Standard	3.0	3.0/4.0/5.0/6.0	1.0	1.7 2.5
Alternate			1.5	2.0 2.8

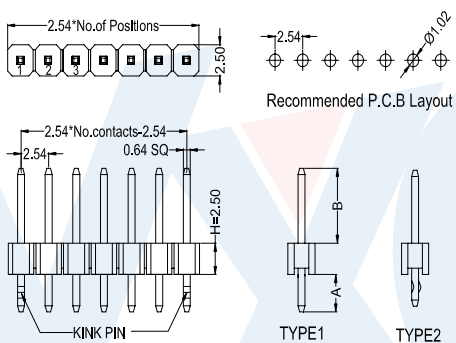

Dimension antitheses list				
ITEM	A	B	D	H
Standard	3.0	3.0/4.0/5.0/6.0	1.2/2.0	1.0 1.7 2.5
Alternate				1.5 2.0 2.8

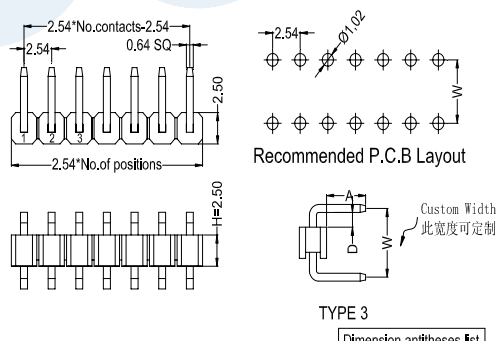
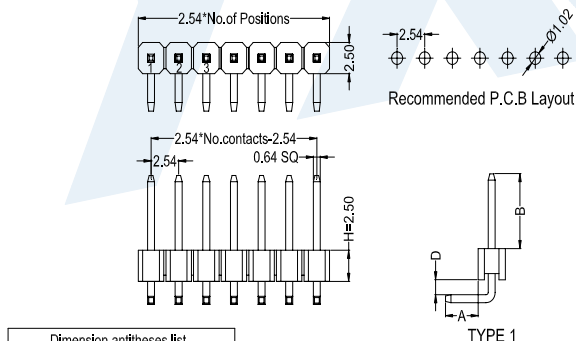
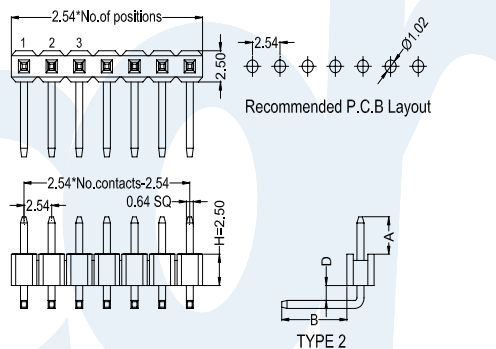

Dimension antitheses list				
ITEM	A	B	D	H
Standard	3.0	3.0/4.0/5.0/6.0	1.2/2.0	1.0 1.7 2.5
Alternate				1.5 2.0 2.8

Dimension antitheses list				
ITEM	A	D	W	H
Standard	3.6	1.2	5.5	1.0 1.7 2.5
Alternate				1.5 2.0 2.8

- P 110 - 11
- P 115 - 11
- P 117 - 11
- P 120 - 11
- P 125 - 11
- P 128 - 11

XX

No.Of Pins Per Row
01~40P

XX

Contact Plating
Full Of Gold A0=0.8u"
Semi-Gold B0=0.8u"
~
A9=30u" B9=30u"
S1=Ordinary Tin Plated
S2=Matte Tin Plated
S3=Tin-plated High-temperature

X

Insulator Material:
A:PBT
B:PA6T
C:PA9T
D:LCP

X

Contact Shape:
S: Straight
R: Right Angle

XXX

Length Of Terminal

X

Packing
A: PE Bag
B: Tape & Reel
C: Tube
D: Tube+CAP
E: Tray

X

Journal Number
1: Type1
2: Type2
3: Type3

Specifications

備注 (Remark)

1. 材料 (Material)

膠芯: PA9T/LCP+30%G.F UL94V-0, 顏色: 黑色
Housing: PA9T/LCP+30%G.F UL94V-0, Color: Black
端子: 黃銅

Contact: Brass

2. 特性 (characteristics):

額定電流: 3.00AMP
Rating Current: 3.00AMP
接觸阻抗: 20mΩ Max
Contact Resistance: 20mΩ Max
絕緣阻抗: 1000MΩ Min
Insulating Resistance: 1000 MΩ Min
耐電壓: AC 500V/分鐘
Withstanding Voltage: AC 500V/Minute
溫度範圍: -40° C to +105° C
Temperture Range: -40° C to +105° C

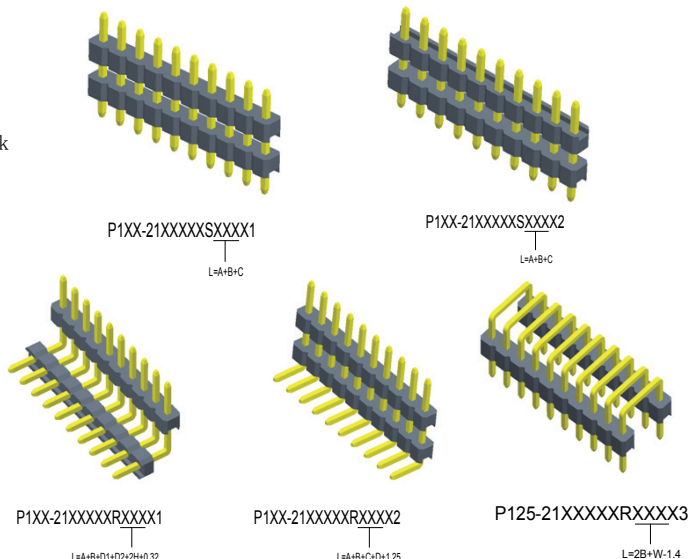

Mating With/配對母座:
F134/F135/F136/F145/F150/F157
F160/F168/F169/F171/F175/F184
F185/F186/F111

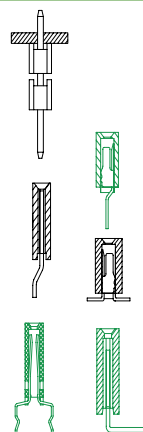

Dimension anitheses list				
ITEM	A	B	C	H
Standard	2.4/3.0	3.0/4.0/5.0/6.0		1.0 1.7 2.5
Alternate				1.5 2.0 2.8

Dimension anitheses list					
ITEM	A	B	C	D	H
Standard	3.00	3.0/4.0/5.0/6.0	0.6/1.2		1.0 1.7 2.5
Alternate					1.5 2.0 2.8

PIN HEADER

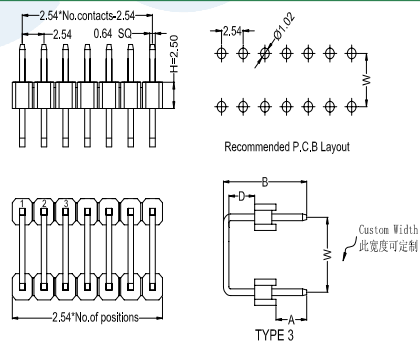
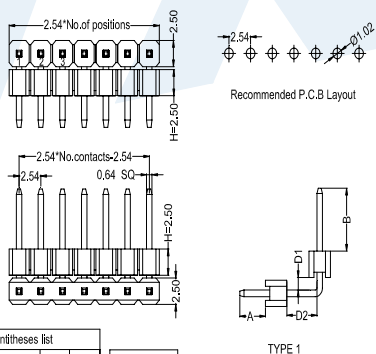
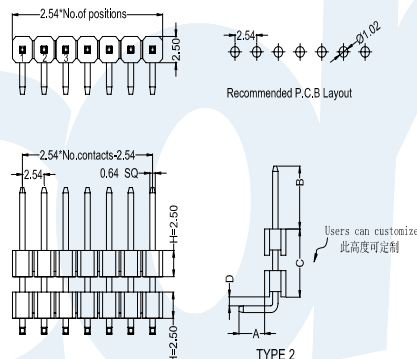
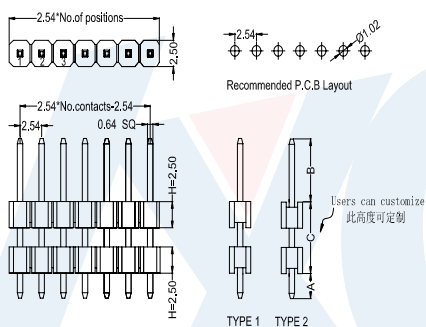

Dimension anitheses list					
ITEM	A	B	D1	D2	H
Standard	3.00	3.0/4.0/5.0/6.0			1.0 1.7 2.5
Alternate					1.5 2.0 2.8

Dimension anitheses list					
ITEM	A	B	D	W	H
Standard	3.60	3.0/4.0/5.0/6.0	1.20		1.0 1.7 2.5
Alternate					1.5 2.0 2.8

- P 110 - 21
- P 115 - 21
- P 117 - 21
- P 120 - 21
- P 125 - 21
- P 128 - 21

XX
No. Of Pins
Per Row
01~40P

XX
Contact Plating
Full Of Gold A0=0.8u"
Semi-Gold B0=0.8u"
~
A9=30u" B9=30u"
S1=Ordinary Tin Plated
S2=Matte Tin Plated
S3=Tin-plated High-temperature

X
Insulator Material:
A: PBT
B: PA6T
C: PA9T
D: LCP

X
Contact Shape:
S: Straight
R: Right Angle

XXX
Length Of Terminal
A: PE Bag
B: Tape & Reel
C: Tube
D: Tube+CAP
E: Tray

X
Journal Number
1: Type1
2: Type2
3: Type3

Http://www.yxcon.com

E-mail: yx@yxcon.com

YUXI DONGGUAN (東莞)
YUXI TAIWAN (台灣)

TEL: +86 769 85397456
TEL: +886 3313 2933

FAX: +86 769 85396015
FAX: +886 3313 2935

Specifications

備注(Remark)

1. 材料(Material)
 膠芯:PA9T/LCP+30%G.F UL94V-0, 顏色:黑色
 Housing:PA9T/LCP+30%G.F UL94V-0, Color:Black
 端子:黃銅
 Contact:Brass

2. 特性(characteristics):
 額定電流:3.00AMP
 Rating Current:3.00AMP
 接觸阻抗:20mΩ Max
 Contact Resistance:20mΩ Max
 絕緣阻抗:1000MΩ Min
 Insulating Resistance:1000 MΩ Min
 耐電壓: AC 500V/分钟
 Withstanding Voltage:AC 500V/Minute
 溫度範圍: -40° C to+105° C
 Temperature Range: -40° C to+105° C

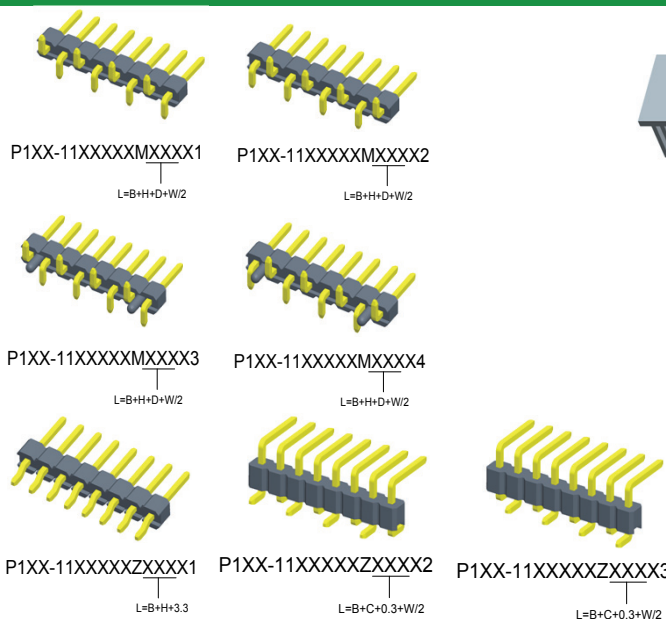

Mating With/配對母座:
 F134/F135/F136/F145/F150/F157
 F160/F168/F169/F171/F175/F184
 F185/F186/F111

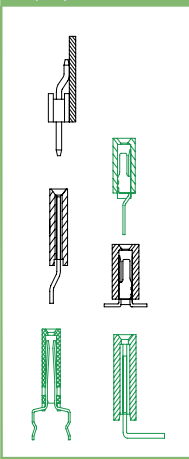

Dimension antitheses list				
ITEM	B	D	W	H
Standard	3.0/4.0/5.0/6.0	0.2/0.6	5.00	1.0 1.7 2.5
Alternate				1.5 2.0 2.8

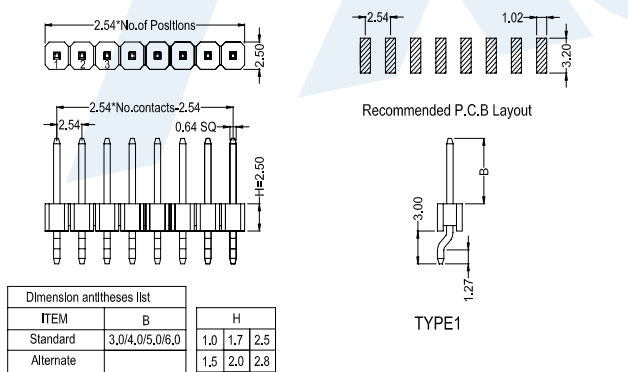
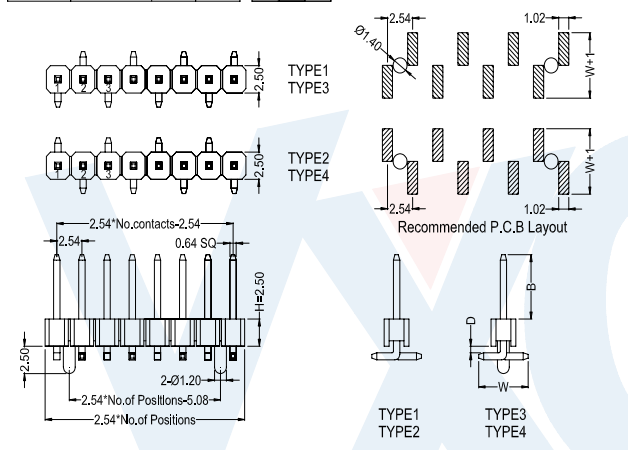

Dimension antitheses list		
ITEM	B	H
Standard	3.0/4.0/5.0/6.0	1.0 1.7 2.5
Alternate		1.5 2.0 2.8

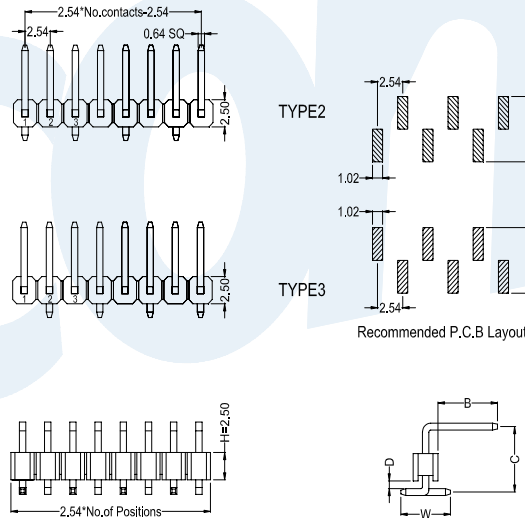

Dimension antitheses list					
ITEM	B	C	D	W	H
Standard	3.0/4.0/5.0/6.0	0.70	5.00		1.0 1.7 2.5
Alternate					1.5 2.0 2.8

PIN HEADER

P 110 - 11	XX	XX	X	X	XXX	X	X
P 115 - 11							
P 117 - 11							
P 120 - 11							
P 125 - 11							
P 128 - 11							
No. Of Pins Per Row	01~40P						
Contact Plating	Full Of Gold A0=0.8u" ~ A9=30u" S1=Ordinary Tin Plated S2=Matte Tin Plated S3=Tin-plated High-temperature	Semi-Gold B0=0.8U"					
Insulator Material:			A:PBT B:PA6T C:PA9T D:LCP				
Contact Shape:				M:SMT Z:90° SMT			
Length Of Terminal							
Packing					A:PE Bag B:Tape & Reel C:Tube D:Tube+CAP E:Tray		
Journal Number							1:Type1 2:Type2 3:Type3 4:Type4

Specifications

備注 (Remark)

1. 材料 (Material)

膠芯: PA9T/LCP+30%G.F UL94V-0, 顏色: 黑色
Housing: PA9T/LCP+30%G.F UL94V-0, Color: Black
端子: 黃銅

Contact: Brass

2. 特性 (characteristics):

額定電流: 3.00AMP
Rating Current: 3.00AMP
接觸阻抗: 20mΩ Max
Contact Resistance: 20mΩ Max
絕緣阻抗: 1000MΩ Min
Insulating Resistance: 1000 MΩ Min
耐電壓: AC 500V/分鐘
Withstanding Voltage: AC 500V/Minute
溫度範圍: -40° C to +105° C
Temperature Range: -40° C to +105° C

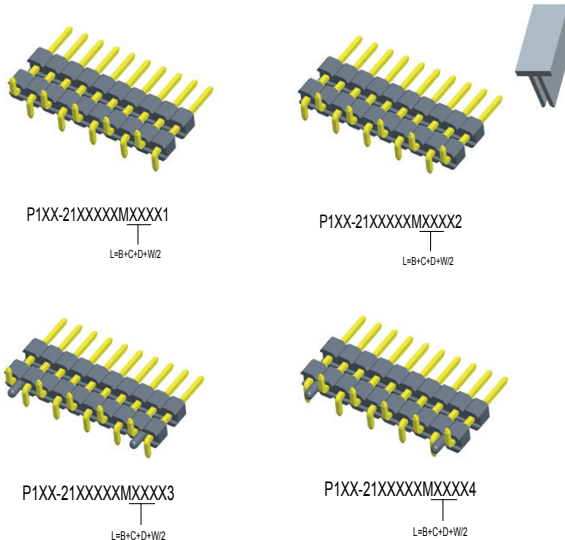

Mating With/配對母座:
F134/F135/F136/F145/F150/F157
F160/F168/F169/F170/F171/F175
F184/F185/F186/F111

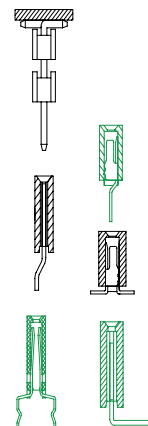

PIN HEADER

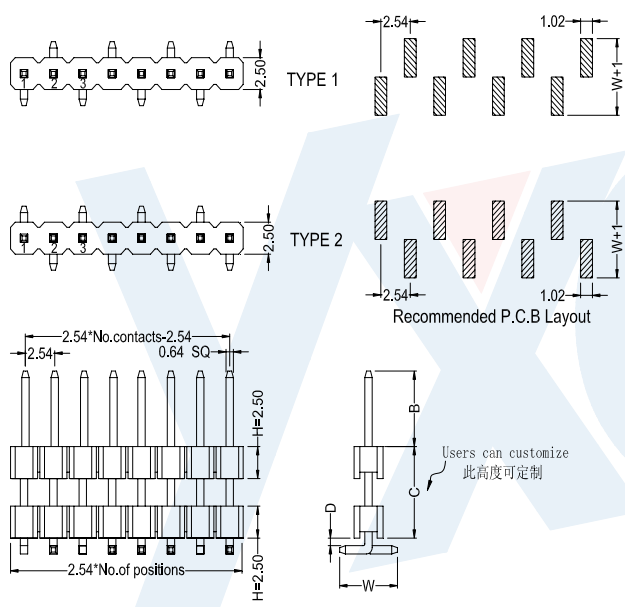

Dimension antitheses list					
ITEM	B	C	D	W	H
Standard	3.0/4.0/5.0/6.0		0.2/0.3	5.00	1.0 1.7 2.5
Alternate					1.5 2.0 2.8

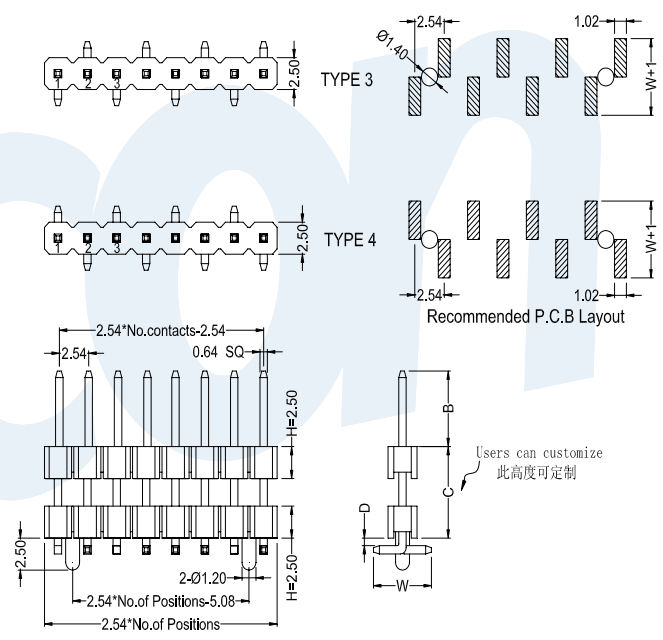

Dimension antitheses list					
ITEM	B	C	D	W	H
Standard	3.0/4.0/5.0/6.0		0.2/0.3	5.00	1.0 1.7 2.5
Alternate					1.5 2.0 2.8

- P 110 - 21
- P 115 - 21
- P 117 - 21
- P 120 - 21
- P 125 - 21
- P 128 - 21

XX	XX	X	M	XXX	X	X
No.Of Pins Per Row 01~40P	Contact Plating Full Of Gold A0=0.8u" Semi-Gold B0=0.8U" ~ A9=30u" B9=30U" S1=Ordinary Tin Plated S2=Matte Tin Plated S3=Tin-plated High-temperature	Insulator Material: A:PBT B:PA6T C:PA9T D:LCP		Length Of Terminal	Packing A:PE Bag B:Tape & Reel C:Tube D:Tube+CAP E:Tray	Journal Number 1:Type1 2:Type2 3:Type3 4:Type4

Specifications

備注 (Remark)

1. 材料 (Material)

膠芯: PA9T/LCP+30%G. F UL94V-0, 顏色: 黑色

Housing: PA9T/LCP+30%G. F UL94V-0, Color: Black

端子: 黃銅

Contact: Brass

2. 特性 (characteristics):

額定電流: 3.00AMP

Rating Current: 3.00AMP

接觸阻抗: 20mΩ Max

Contact Resistance: 20mΩ Max

絕緣阻抗: 1000MΩ Min

Insulating Resistance: 1000 MΩ Min

耐電壓: AC 500V/分鐘

Withstanding Voltage: AC 500V/Minute

溫度範圍: -40° C to +105° C

Temperture Range: -40° C to +105° C

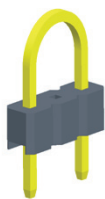

P125-1103XXXU242X1

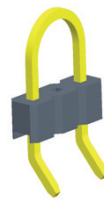

P125-1103XXXU252X1

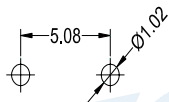
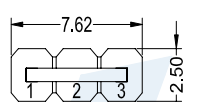

Recommended P.C.B Layout

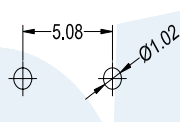
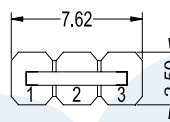
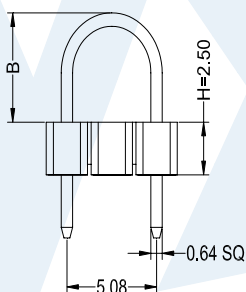

Recommended P.C.B Layout

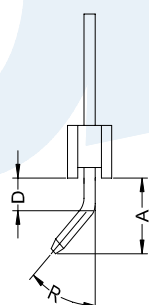
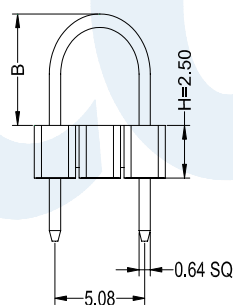

Dimension antitheses list			
ITEM	A	B	
Standard	3.00	5.20	
Alternate			

Dimension antitheses list				
ITEM	A	B	D	R
Standard	3.60	5.30	1.55	45°
Alternate				

P 125 - 11

03

XX

X

U

XXX

X

1

Contact Plating

Full Of Gold Semi-Gold

A0=0.8u" B0=0.8U"

~ ~

A9=30u" B9=30U"

S1=Ordinary Tin Plated

S2=Matte Tin Plated

S3=Tin-plated High-temperature

Insulator Material:

A:PBT

B:PA6T

C:PA9T

D:LCP

Length Of Terminal

Packing

A:PE Bag

B:Tape & Reel

C:Tube

D:Tube+CAP

E:Tray

Specifications

備注 (Remark)

1. 材料 (Material)

膠芯: PA9T/LCP+30%G.F UL94V-0, 顏色: 黑色

Housing: PA9T/LCP+30%G.F UL94V-0, Color: Black

端子: 黃銅

Contact: Brass

2. 特性 (characteristics):

額定電流: 3.00AMP

Rating Current: 3.00AMP

接觸阻抗: 20mΩ Max

Contact Resistance: 20mΩ Max

絕緣阻抗: 1000MΩ Min

Insulating Resistance: 1000 MΩ Min

耐電壓: AC 500V/分鐘

Withstanding Voltage: AC 500V/Minute

溫度範圍: -40° C to +105° C

Temperature Range: -40° C to +105° C

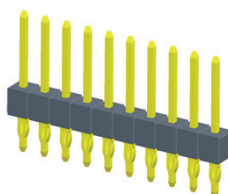

P125-11XXXXXSXXX1

L=A+B+2.5

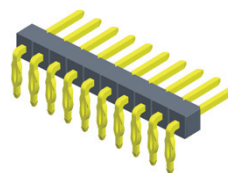

P125-11XXXXRXXX1

L=A+B+3.8

Mating With/配對母座:
F134/F135/F136/F145/F150/F157
F160/F168/F169/F170/F171/F175
F184/F185/F186/F111

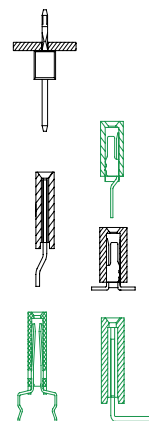

PIN HEADER

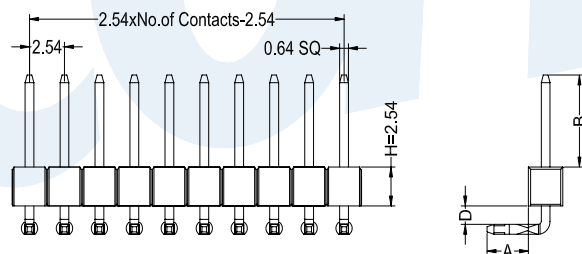
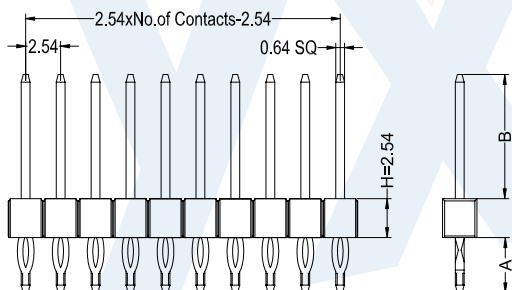
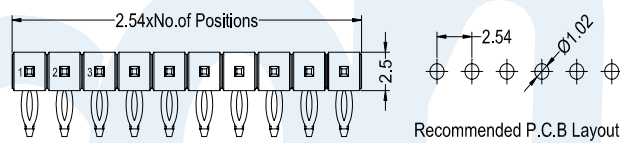
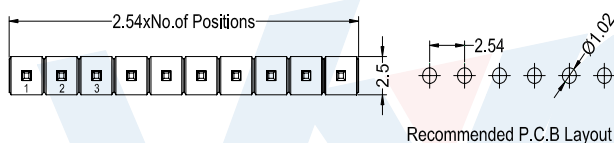

Dimension antitheses list		
ITEM	A	B
Standard	3.6	3.0/4.0/5.0/6.0
Alternate		

Dimension antitheses list			
ITEM	A	B	D
Standard	3.0	3.0/4.0/5.0/6.0	1.2
Alternate			

P 1 2 5 - 1 1 **XX** **XX** **X** **X** **XXX** **X** **1**

No.Of Pins Per Row 01~40P

Contact Plating
Full Of Gold A0=0.8u"
Semi-Gold B0=0.8u"
~
A9=30u" B9=30u"
S1=Ordinary Tin Plated
S2=Matte Tin Plated
S3=Tin-plated High-temperature

Insulator Material:
A:PBT
B:PA6T
C:PA9T
D:LCP

Contact Shape:
S: Straight
R: Right Angle

Length Of Terminal

Packing
A: PE Bag
B: Tape & Reel
C: Tube
D: Tube+CAP
E: Tray

Http://www.yxcon.com

E-mail:yx@yxcon.com

YUXI DONGGUAN (東莞)
YUXI TAIWAN (台灣)

TEL:+86 769 85397456
TEL:+886 3313 2933

FAX:+86 769 85396015
FAX:+886 3313 2935

Specifications

備注 (Remark)

1. 材料 (Material)

膠芯: PA9T/LCP+30%G. F UL94V-0, 顏色: 黑色

Housing: PA9T/LCP+30%G. F UL94V-0, Color: Black

端子: 黃銅

Contact: Brass

2. 特性 (characteristics):

額定電流: 3.00AMP

Rating Current: 3.00AMP

接觸阻抗: 20mΩ Max

Contact Resistance: 20mΩ Max

絕緣阻抗: 1000MΩ Min

Insulating Resistance: 1000 MΩ Min

耐電壓: AC 500V/分鐘

Withstanding Voltage: AC 500V/Minute

溫度範圍: -40° C to +105° C

Temperature Range: -40° C to +105° C

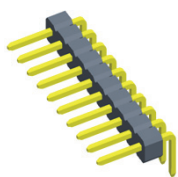

P125-11XXXXRXXXX4
 L=A+B+D+2.5+1.78

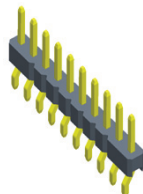

P125-11XXXXZXXXX4
 L=B+3.0+3.0

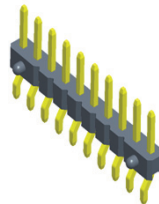

P125-11XXXXZXXXX5
 L=B+3.0+3.0

Mating With/配對母座:
 F134/F135/F138/F145/F150/F157
 F160/F168/F169/F170/F171/F175
 F184/F185/F186/F111

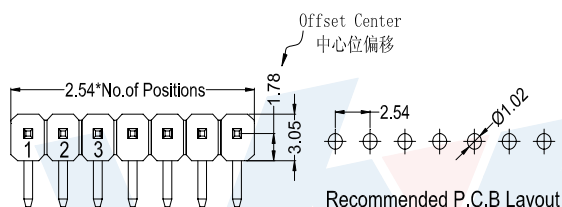
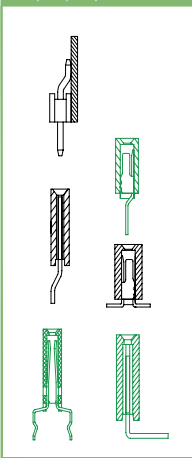

Recommended P.C.B Layout

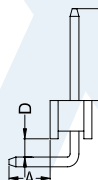
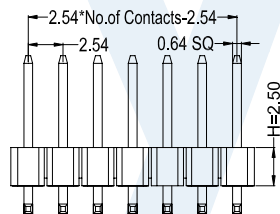

TYPE 4

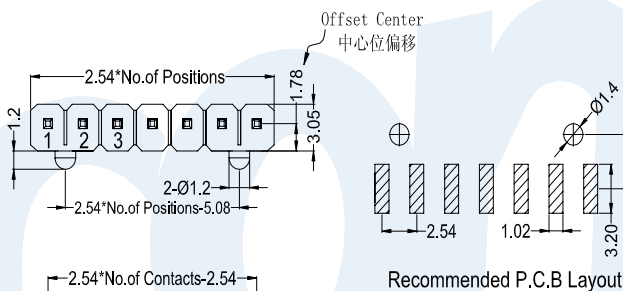

Recommended P.C.B Layout

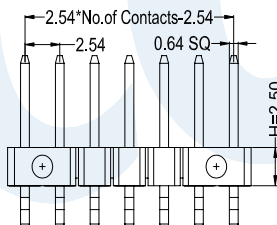

TYPE 4

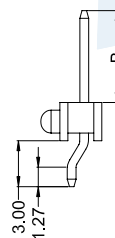

TYPE 5

Dimension antitheses list			
ITEM	A	B	D
Standard	3.0	3.0/4.0/5.0/6.0	1.2
Alternate			

Dimension antitheses list	
ITEM	B
Standard	3.0/4.0/5.0/6.0
Alternate	

P 1 2 5 - 1 1

X X

X X

X

X

X X X

X

X

No.Of Pins Per Row
 01~40P

Contact Plating
 Full Of Gold A0=0.8u" B0=0.8U"
 ~
 Semi-Gold A9=30u" B9=30U"

Insulator Material:
 A:PBT
 B:PA6T
 C:PA9T
 D:LCP

Contact Shape:
 R:Right Angle
 Z:90° SMT

Length Of Terminal

Packing
 A:PE Bag
 B:Tape & Reel
 C:Tube
 D:Tube+CAP
 E:Tray

Journal Number
 4:Type4
 5:Type5

S1=Ordinary Tin Plated
 S2=Matte Tin Plated
 S3=Tin-plated High-temperature

[Http://www.yxcon.com](http://www.yxcon.com)

E-mail:yx@yxcon.com

YUXI DONGGUAN (東莞)
 YUXI TAIWAN (台灣)

TEL:+86 769 85397456
 TEL:+886 3313 2933

FAX:+86 769 85396015
 FAX:+886 3313 2935

Specifications

備注 (Remark)

1. 材料 (Material)

膠芯: PA9T/LCP+30%G. F UL94V-0, 顏色: 黑色

Housing: PA9T/LCP+30%G. F UL94V-0, Color: Black

端子: 黃銅

Contact: Brass

2. 特性 (characteristics):

額定電流: 3.00AMP

Rating Current: 3.00AMP

接觸阻抗: 20mΩ Max

Contact Resistance: 20mΩ Max

絕緣阻抗: 1000MΩ Min

Insulating Resistance: 1000 MΩ Min

耐電壓: AC 500V/分鐘

Withstanding Voltage: AC 500V/Minute

溫度範圍: -40° C to +105° C

Temperture Range: -40° C to +105° C

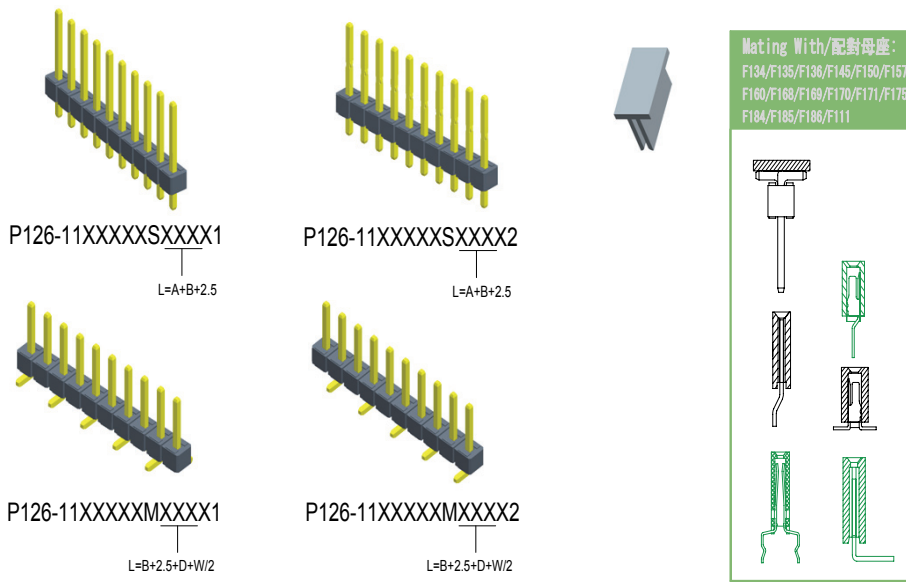

Dimension antitheses list		
ITEM	A	B
Standard	2.60	11.4
Alternate		

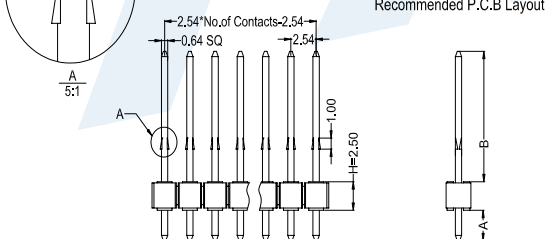
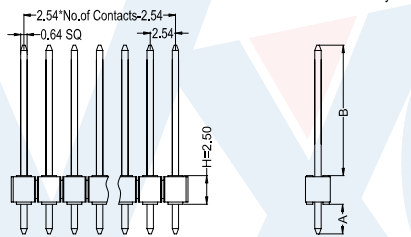
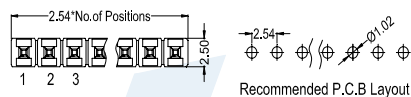

Dimension antitheses list		
ITEM	A	B
Standard	2.60	11.4
Alternate		

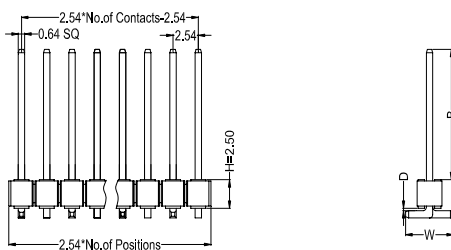
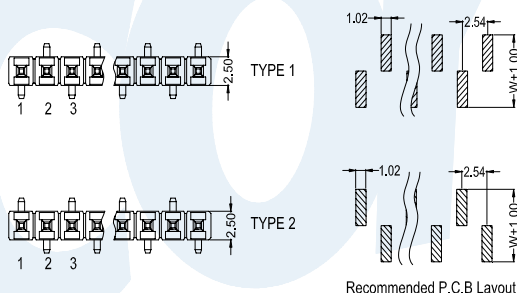

Dimension antitheses list			
ITEM	B	D	W
Standard	11.4	0.60	4.80
Alternate			

P 1 2 6 - 1 1	X X	X X	X	X	X X X	X	X
No. Of Pins Per Row 01~40P	Contact Plating Full Of Gold A0=0.8u" ~ A9=30u" S1=Ordinary Tin Plated S2=Matte Tin Plated S3=Tin-plated High-temperature	Insulator Material: A: PBT B: PA6T C: PA9T D: LCP	Contact Shape: S: Straight M: SMT	Length Of Terminal	Packing A: PE Bag B: Tape & Reel C: Tube D: Tube+CAP E: Tray	Journal Number 1: Type1 2: Type2	

[Http://www.yxcon.com](http://www.yxcon.com) [E-mail:yx@yxcon.com](mailto:yx@yxcon.com)

YUXI DONGGUAN (東莞) TEL:+86 769 85397456 FAX:+86 769 85396015
 YUXI TAIWAN (台灣) TEL:+886 3313 2933 FAX:+886 3313 2935