

Specifications

備注 (Remark)

1. 材料 (Material)

膠芯: PA9T/LCP+30%G. F UL94V-0, 顏色: 黑色

Housing: PA9T/LCP+30%G. F UL94V-0, Color: Black

端子: 黃銅

Contact: Brass

2. 特性 (characteristics):

額定電流: 2.0AMP

Rating Current: 2.0AMP

接觸阻抗: 20mΩ Max

Contact Resistance: 20mΩ Max

絕緣阻抗: 1000MΩ Min

Insulating Resistance: 1000 MΩ Min

耐電壓: AC 500V/分鐘

Withstanding Voltage: AC 500V/Minute

溫度範圍: -40° C to +105° C

Temperature Range: -40° C to +105° C

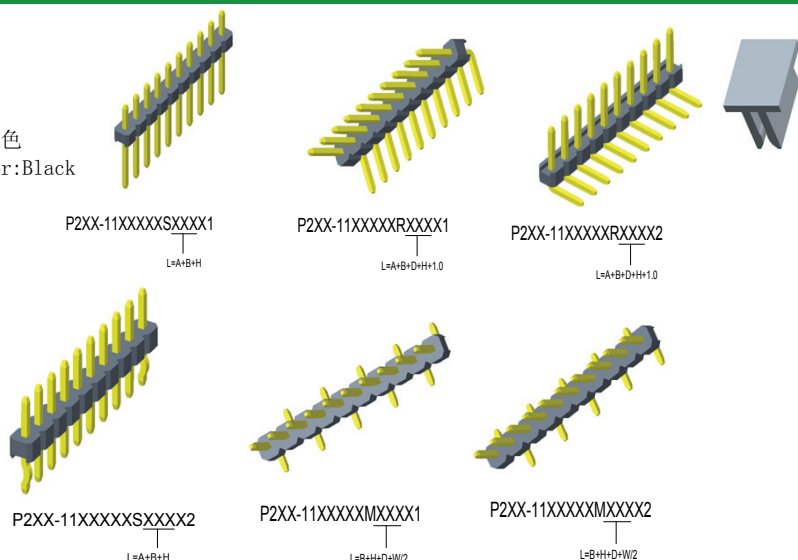

Mating With/配對母座:

F220/F221/F221/F228/F235
F240/F243/F246/F255/F263

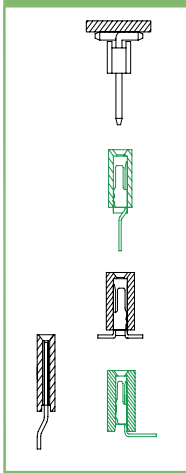

Dimension antitheses list			
ITEM	A	B	H
Standard	2.80	2.0/3.0/4.0	1.0 2.0
Alternate			1.5 2.5

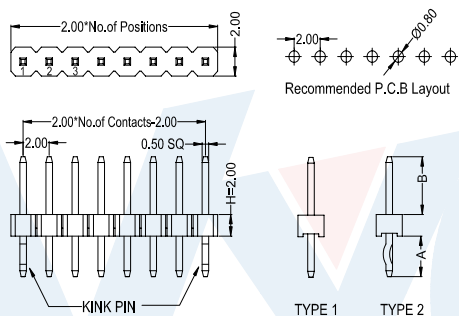

Dimension antitheses list				
ITEM	A	B	D	H
Standard	2.80	2.0/3.0/4.0	0.75	1.0 2.0
Alternate				1.5 2.5

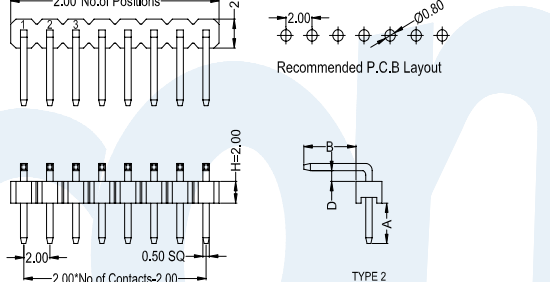

Dimension antitheses list				
ITEM	A	B	D	H
Standard	2.80	2.0/3.0/4.0	0.75	1.0 2.0
Alternate				1.5 2.5

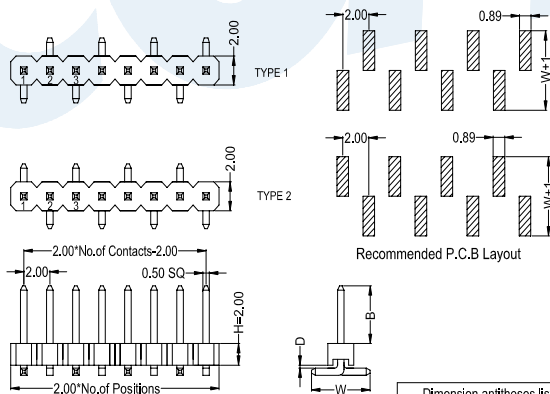
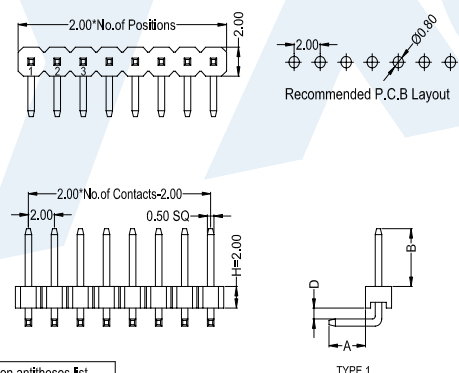

Dimension antitheses list				
ITEM	B	D	W	H
Standard	2.0/3.0/4.0	0.10	4.50	1.0 2.0
Alternate				1.5 2.5

- P 210 - 11
- P 215 - 11
- P 220 - 11
- P 225 - 11

XX
No.Of Pins
Per Row
01~40P

XX
Contact Plating
Full Of Gold A0=0.8u"
Semi-Gold B0=0.8U"
~
A9=30u" B9=30U"
S1=Ordinary Tin Plated
S2=Matte Tin Plated
S3=Tin-plated High-temperature

X
Insulator Material:
A:PBT
B:PA6T
C:PA9T
D:LCP

X
Contact Shape:
S: Straight
R: Right Angle
M: SMT

XXX
Length Of Terminal

X
Packing
A: PE Bag
B: Tape & Reel
C: Tube
D: Tube+CAP
E: Tray

X
Journal Number
1: Type1
2: Type2

Specifications

備注 (Remark)

1. 材料 (Material)

膠芯: PA9T/LCP+30%G. F UL94V-0, 顏色: 黑色

Housing: PA9T/LCP+30%G. F UL94V-0, Color: Black

端子: 黃銅

Contact: Brass

2. 特性 (characteristics):

額定電流: 2.0AMP

Rating Current: 2.0AMP

接觸阻抗: 20mΩ Max

Contact Resistance: 20mΩ Max

絕緣阻抗: 1000MΩ Min

Insulating Resistance: 1000 MΩ Min

耐電壓: AC 500V/分鐘

Withstanding Voltage: AC 500V/Minute

溫度範圍: -40° C to +105° C

Temperature Range: -40° C to +105° C

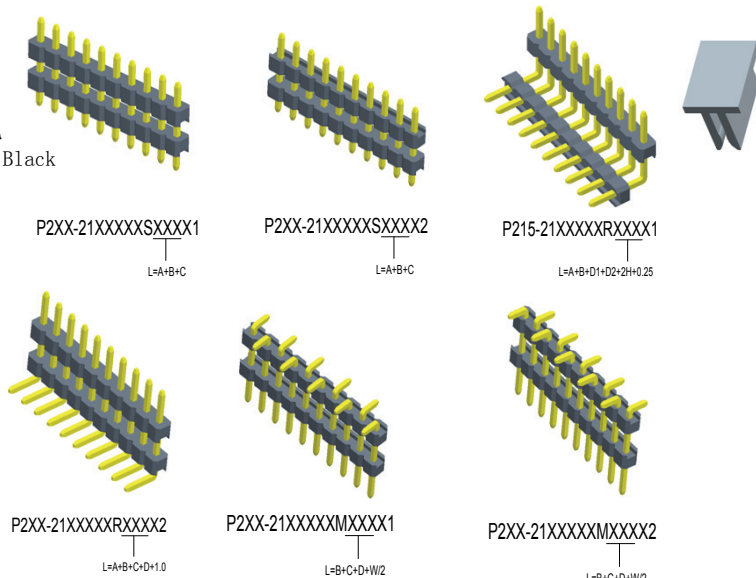

Mating With/配對母座:

F220/F221/F227/F228/F235
F240/F243/F246/F255/F263

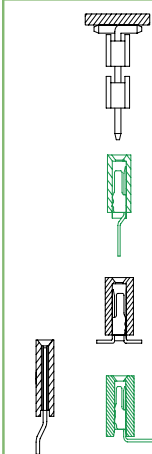

Dimension antitheses list				
ITEM	A	B	C	H
Standard	2.80	2.0/3.0/4.0		1.0 2.0 1.5 2.5
Alternate				

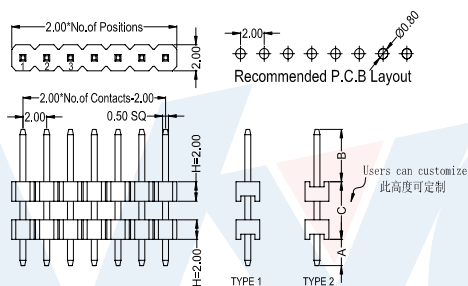

Dimension antitheses list					
ITEM	A	B	C	D	H
Standard	2.80	2.0/3.0/4.0		0.75	1.0 2.0 1.5 2.5
Alternate					

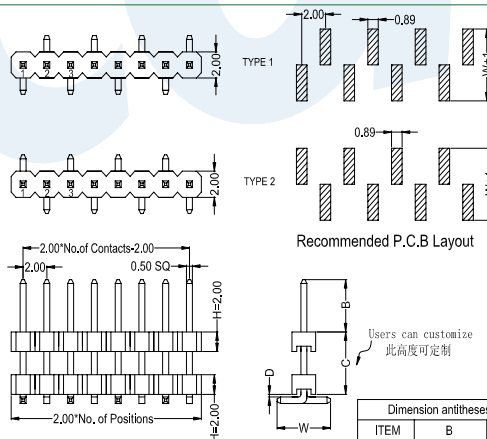
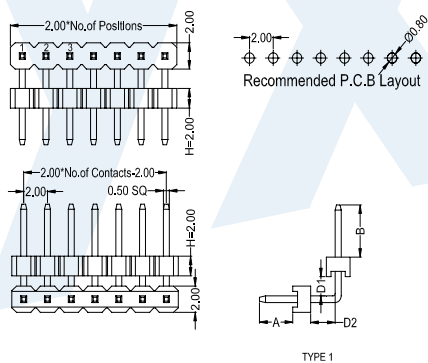
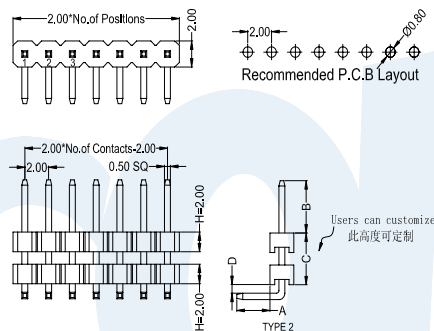

Dimension antitheses list					
ITEM	A	B	D1	D2	H
Standard	2.80	2.0/3.0/4.0			1.0 2.0 1.5 2.5
Alternate					

Dimension antitheses list					
ITEM	B	C	D	W	H
Standard	2.0/3.0/4.0		0.10	4.50	1.0 2.0 1.5 2.5
Alternate					

P 210 - 21
P 215 - 21
P 220 - 21
P 225 - 21

XX
No. Of Pins
Per Row
01~40P

XX
Contact Plating
Full Of Gold A0=0.8u"
Semi-Gold B0=0.8u"
A9=30u" B9=30u"
S1=Ordinary Tin Plated
S2=Matte Tin Plated
S3=Tin-plated High-temperature

X
Insulator Material:
A:PBT
B:PA6T
C:PA9T
D:LCP

X
Contact Shape:
S: Straight
R: Right Angle
M: SMT

XXX
Length Of
Terminal
A: PE Bag
B: Tape & Reel
C: Tube
D: Tube+CAP
E: Tray

X
Journal Number
1: Type1
2: Type2

Specifications

備注 (Remark)

1. 材料 (Material)

膠芯: PA9T/LCP+30%G. F UL94V-0, 顏色: 黑色

Housing: PA9T/LCP+30%G. F UL94V-0, Color: Black

端子: 黃銅

Contact: Brass

2. 特性 (characteristics):

額定電流: 2.0AMP

Rating Current: 2.0AMP

接觸阻抗: 20mΩ Max

Contact Resistance: 20mΩ Max

絕緣阻抗: 1000MΩ Min

Insulating Resistance: 1000 MΩ Min

耐電壓: AC 500V/分钟

Withstanding Voltage: AC 500V/Minute

溫度範圍: -40° C to +105° C

Temperature Range: -40° C to +105° C

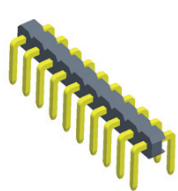

P220-11XXXXXRXXXX3
L=2A*2D+4.0

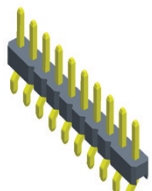

P220-11XXXXXZXXXX1
L=B*2B+2.2

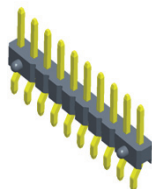

P220-11XXXXXZXXXX2
L=B*2B+2.2

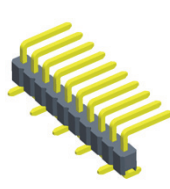

P220-11XXXXXZXXXX3
L=B*C+0.3*W/2

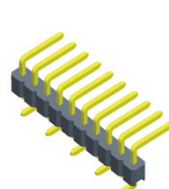

P220-11XXXXXZXXXX4
L=B*C+0.3*W/2

Mating With/配對母座:

F220/F221/F222/F228/F235
F240/F243/F246/F255/F263

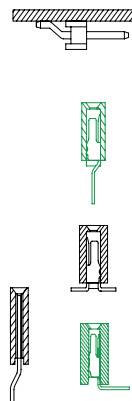

Dimension antitheses list			
ITEM	A	W	D
Standard	2.8	4.0	0.75
Alternate			

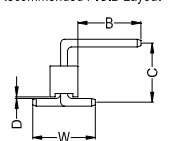
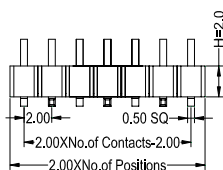
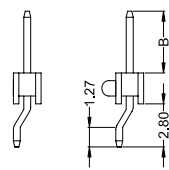
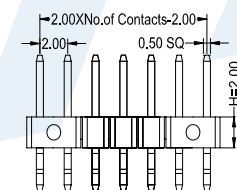
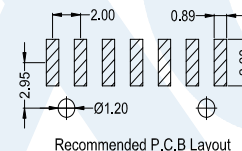
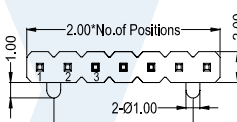
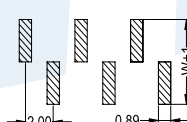
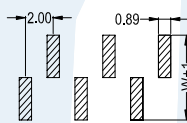
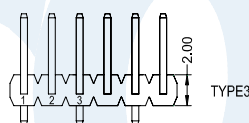
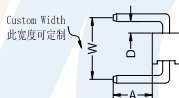
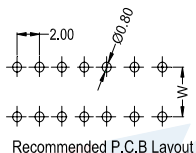
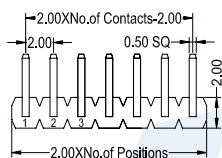

Dimension antitheses list	
ITEM	B
Standard	2.0/3.0/4.0
Alternate	

Dimension antitheses list				
ITEM	B	C	D	W
Standard	2.0/3.0/4.0		0.10	4.50
Alternate				

P 2 2 0 - 1 1

X X

X X

X

X

X X X

X

X

No.Of Pins Per Row
01~40P

Contact Plating
Full Of Gold Semi-Gold
A0=0.8u" B0=0.8U"

A9=30u" B9=30U"
S1=Ordinary Tin Plated
S2=Matte Tin Plated
S3=Tin-plated High-temperature

Insulator Material:
A: PBT
B: PA6T
C: PA9T
D: LCP

Contact Shape:
R: Right Angle
Z: 90° SMT

Length Of Terminal

Packing
A: PE Bag
B: Tape & Reel
C: Tube
D: Tube+CAP
E: Tray

Journal Number
1: Type1
2: Type2
3: Type3
4: Type4

Specifications

備注 (Remark)

1. 材料 (Material)

膠芯: PA9T/LCP+30%G. F UL94V-0, 顏色: 黑色
Housing: PA9T/LCP+30%G. F UL94V-0, Color: Black
端子: 黃銅

Contact: Brass

2. 特性 (characteristics):

額定電流: 2.0AMP
Rating Current: 2.0AMP
接觸阻抗: 20mΩ Max
Contact Resistance: 20mΩ Max
絕緣阻抗: 1000MΩ Min
Insulating Resistance: 1000 MΩ Min
耐電壓: AC 500V/分鐘
Withstanding Voltage: AC 500V/Minute
溫度範圍: -40° C to +105° C
Temperature Range: -40° C to +105° C

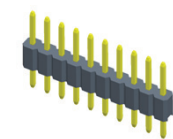

P227-11XXXXXSXXXX1
L=A+B+2.7

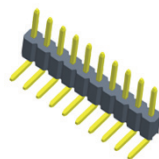

P227-11XXXXXRXXXX1
L=A+B+D+3.7

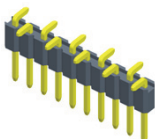

P227-11XXXXMXXXXX1
L=B+2.7+D+W/2

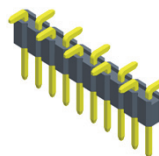

P227-11XXXXMXXXXX2
L=B+2.7+D+W/2

Mating With/配對母座:

F220/F221/F227/F228/F235
F240/F243/F248/F255/F263

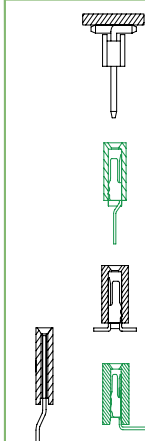

Dimension anitheses list		
ITEM	A	B
Standard	2.80	2.0/3.0/4.0
Alternate		

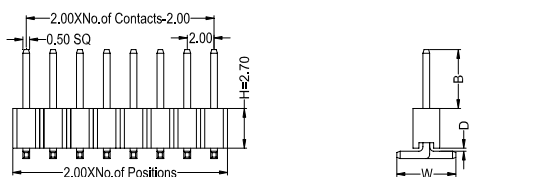
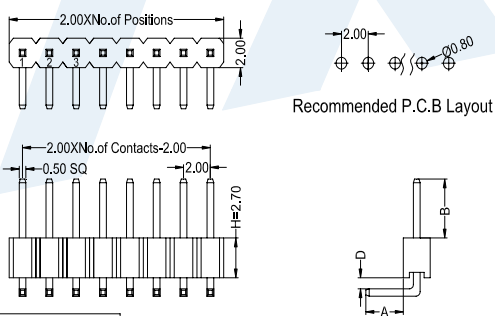
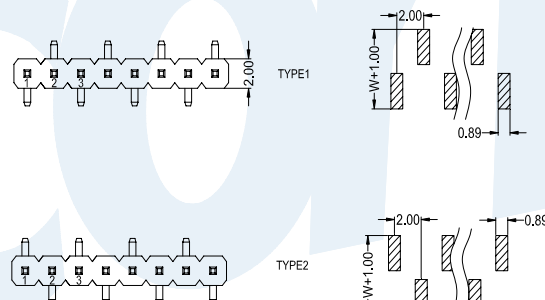
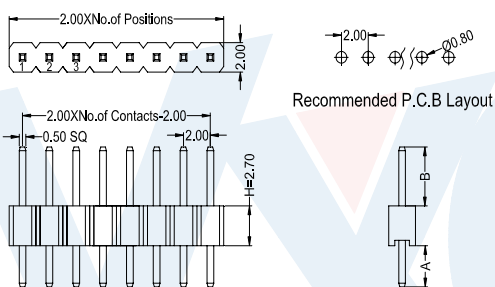

Dimension anitheses list			
ITEM	A	B	D
Standard	2.80	2.0/3.0/4.0	0.75
Alternate			

Dimension anitheses list			
ITEM	B	D	W
Standard	2.0/3.0/4.0	0.75	4.40
Alternate			

P 2 2 7 - 1 1

X X

X X

X

X

X X X

X

X

No.Of Pins Per Row
01~40P

Contact Plating
Full Of Gold Semi-Gold
A0=0.8u" B0=0.8U"

~ ~
A9=30u" B9=30U"

S1=Ordinary Tin Plated
S2=Matte Tin Plated
S3=Tin-plated High-temperature

Insulator Material:

A:PBT
B:PA6T
C:PA9T
D:LCP

Contact Shape:

S: Straight
R: Right Angle
M: SMT

Length Of Terminal

Packing

A: PE Bag
B: Tape & Reel
C: Tube
D: Tube+CAP
E: Tray

Journal Number

1: Type1
2: Type2

Http://www.yxcon.com

E-mail:yx@yxcon.com

YUXI DONGGUAN (東莞)
YUXI TAIWAN (台灣)

TEL:+86 769 85397456
TEL:+886 3313 2933

FAX:+86 769 85396015
FAX:+886 3313 2935