

Specifications

備注 (Remark)

1. 材料 (Material)

膠芯: PA9T/LCP+30%G. F UL94V-0, 顏色: 黑色

Housing: PA9T/LCP+30%G. F UL94V-0, Color: Black

端子: 黃銅

Contact: Brass

2. 特性 (characteristics):

額定電流: 0.75AMP

Rating Current: 0.75AMP

接觸阻抗: 20mΩ Max

Contact Resistance: 20mΩ Max

絕緣阻抗: 1000MΩ Min

Insulating Resistance: 1000 MΩ Min

耐電壓: AC 500V/分钟

Withstanding Voltage: AC 500V/Minute

溫度範圍: -40° C to +105° C

Temperature Range: -40° C to +105° C

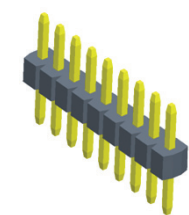

P5XX-11XXXXXSXXXX1

$$L=A+B+H$$

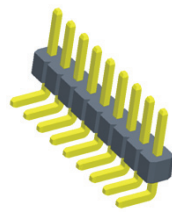

P5XX-11XXXXRXXXXX1

$$L=A+B+D+H+0.75$$

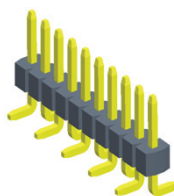

P5XX-11XXXXMXXXXX1

$$L=B+H+D+W/2$$

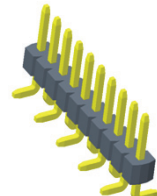

P5XX-11XXXXMXXXXX2

$$L=B+H+D+W/2$$

Mating With/配對母座:
F520/F521/F530

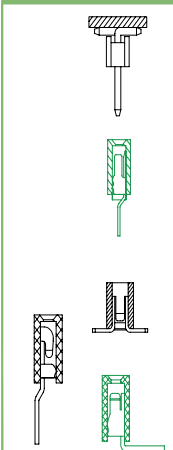

Dimension antitheses list				
ITEM	A	B	H	
Standard	1.2	1.8	1.0	
	1.8		1.5	
Alternate			2.0	

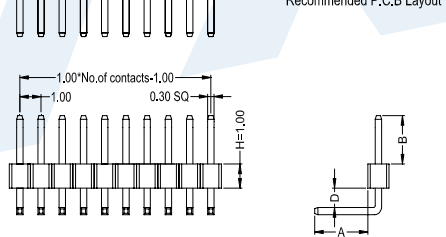
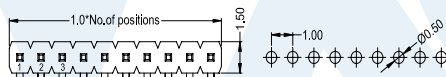
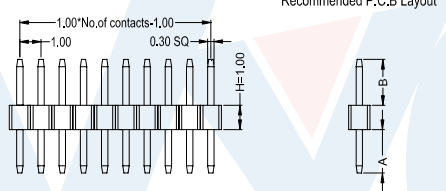
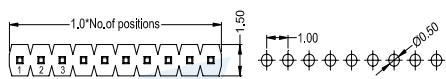

Dimension antitheses list				
ITEM	A	B	D	H
Standard	2.5	1.8	0.8	1.0
				1.5
Alternate				2.0

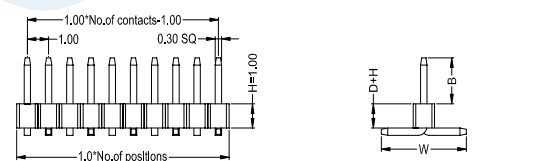
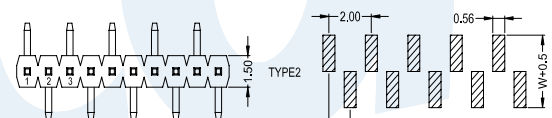
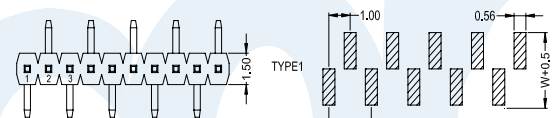

Dimension antitheses list				
ITEM	B	D	W	H
Standard	1.8	0	4.0	1.0
				1.5
Alternate				2.0

P 5 1 0 - 1 1
P 5 1 5 - 1 1
P 5 2 0 - 1 1

XX

XX

X

X

XXX

X

X

No. Of Pins Per Row
02~50P

Contact Plating
Full Of Gold A0=0.8u"
Semi-Gold B0=0.8U"

Insulator Material:
C: PA9T
D: LCP

Contact Shape:
S: Straight
R: Right Angle
M: SMT

Length Of Terminal

Packing
A: PE Bag
B: Tape & Reel
C: Tube
D: Tube+CAP
E: Tray

Journal Number
1: Type1
2: Type2

A9=30u" B9=30U"
S1=Ordinary Tin Plated
S2=Matte Tin Plated
S3=Tin-plated High-temperature

Http://www.yxcon.com

E-mail:yx@yxcon.com

YUXI DONGGUAN (東莞)
YUXI TAIWAN (台灣)

TEL:+86 769 85397456
TEL:+886 3313 2933

FAX:+86 769 85396015
FAX:+886 3313 2935

Specifications

備注 (Remark)

1. 材料 (Material)

膠芯: PA9T/LCP+30%G. F UL94V-0, 顏色: 黑色

Housing: PA9T/LCP+30%G. F UL94V-0, Color: Black

端子: 黃銅

Contact: Brass

2. 特性 (characteristics):

額定電流: 0.75AMP

Rating Current: 0.75AMP

接觸阻抗: 20mΩ Max

Contact Resistance: 20mΩ Max

絕緣阻抗: 1000MΩ Min

Insulating Resistance: 1000 MΩ Min

耐電壓: AC 500V/分鐘

Withstanding Voltage: AC 500V/Minute

溫度範圍: -40° C to +105° C

Temperature Range: -40° C to +105° C

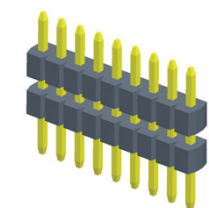

P5XX-21XXXXXSXXXX1

L=A+B+C

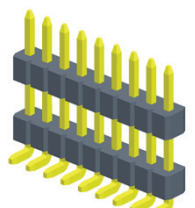

P5XX-21XXXXXRXXXX1

L=A+B+C+D+0.75

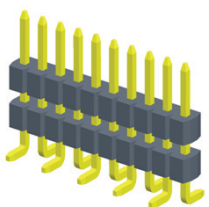

P5XX-21XXXXMXXXXX1

L=B+C+D+W/2

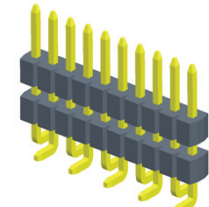

P5XX-21XXXXMXXXX2

L=B+C+D+W/2

Mating With/配對母座:
F520/F521/F530

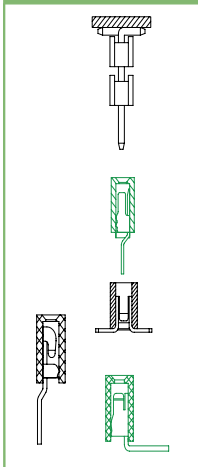

Dimension antitheses list				
ITEM	A	B	C	H
Standard	1.2	1.8		1.0
Alternate	1.8			1.5
				2.0

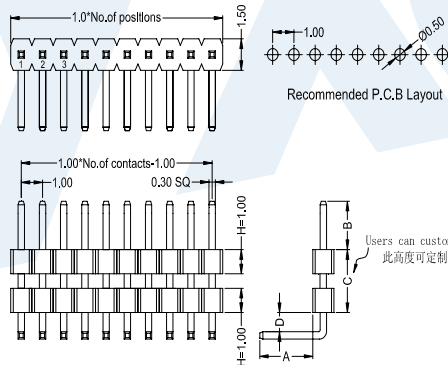
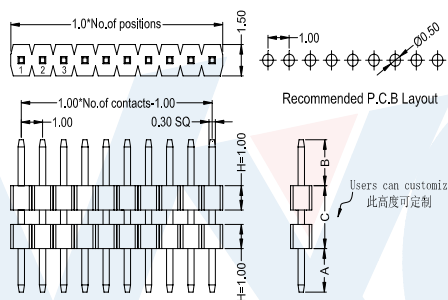

Dimension antitheses list					
ITEM	A	B	C	D	H
Standard	2.5	1.8		0.8	1.0
					1.5
Alternate					2.0

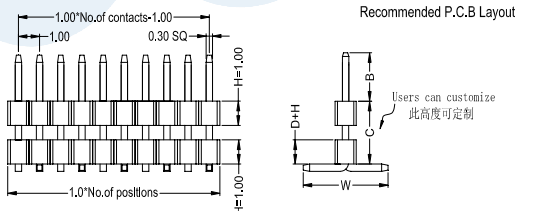
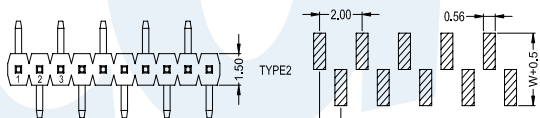
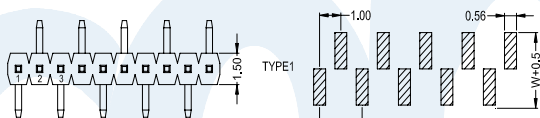

Dimension antitheses list					
ITEM	B	C	D	W	H
Standard	1.8		0	4.0	1.0
					1.5
Alternate					2.0

P 5 1 0 - 2 1
P 5 1 5 - 2 1
P 5 2 0 - 2 1

XX
No. Of Pins
Per Row
02~50P

XX
Contact Plating
Full Of Gold A0=0.8u"
Semi-Gold B0=0.8U"
A9=30u" B9=30U"
S1=Ordinary Tin Plated
S2=Matte Tin Plated
S3=Tin-plated High-temperature

X
Insulator Material:
C:PA9T
D:LCP

X
Contact Shape:
S: Straight
R: Right Angle
M: SMT

XXX
Length Of
Terminal

X
Packing
A: PE Bag
B: Tape & Reel
C: Tube
D: Tube+CAP
E: Tray

X
Journal Number
1: Type1
2: Type2