

**Specifications**

備注 (Remark)

1. 材料 (Material)

膠芯: PA9T/LCP+30% G. F UL94V-0, 顏色: 黑色

Housing: PA9T/LCP+30% G. F UL94V-0,

Color: Black

端子: 磷銅

Contact: Phosphor Bronze

2. 特性 (characteristics):

額定電流: 1.0AMP

Rating Current: 1.0AMP

接觸阻抗: 20mΩ Max

Contact Resistance: 20mΩ Max

絕緣阻抗: 1000MΩ Min

Insulating Resistance: 1000 MΩ Min

耐電壓: AC 500V/分鐘

Withstanding Voltage: AC 500V/Minute

溫度範圍: -55° C to +125° C

Temperture Range: -55° C to +125° C

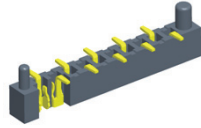

F320-11XXXXXMPX1

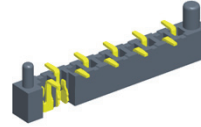

F320-11XXXXXMPX2

Mating With/配對公座:  
P310/P315/P316/P317/P320/P325

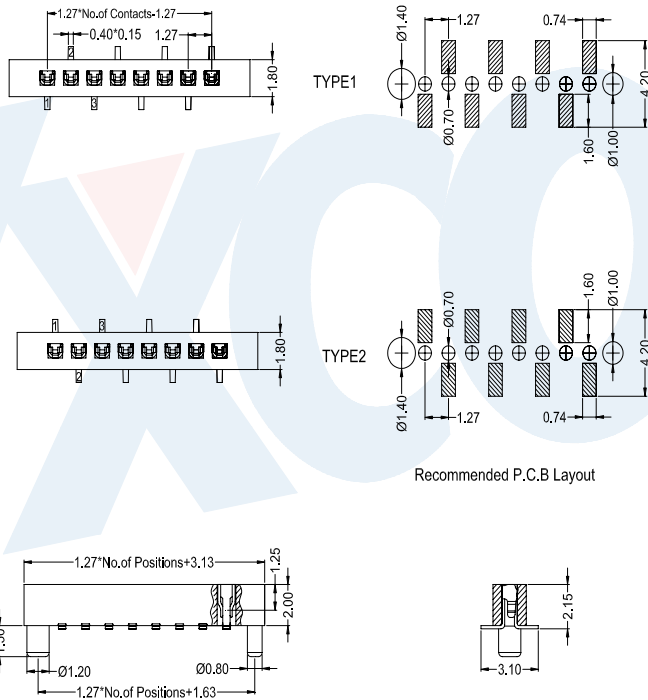
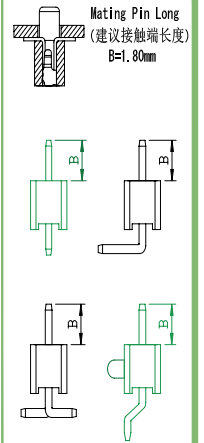

FEMALE HEADER

<b>F 3 2 0 - 1 1</b>	<b>X X</b>	<b>X X</b>	<b>X</b>	<b>M</b>	<b>P</b>	<b>X</b>	<b>X</b>
<b>No. Of Pins Per Row</b> 02~50P	<b>Contact Plating</b> Full Of Gold A0=0.8u" ~ A9=30u" S1=Ordinary Tin Plated S2=Matte Tin Plated S3=Tin-plated High-temperature	<b>Insulator Material:</b> B: PA6T C: PA9T D: LCP				<b>Packing</b> A: PE Bag B: Tape & Reel C: Tube D: Tube+CAP E: Tray	<b>Journal Number</b> 1: Type1 2: Type2

**Specifications**

備注 (Remark)

1. 材料 (Material)

膠芯: PA9T/LCP+30% G.F UL94V-0, 顏色: 黑色

Housing: PA9T/LCP+30% G.F UL94V-0,

Color: Black

端子: 磷銅

Contact: Phosphor Bronze

2. 特性 (characteristics):

額定電流: 1.0AMP

Rating Current: 1.0AMP

接觸阻抗: 20mΩ Max

Contact Resistance: 20mΩ Max

絕緣阻抗: 1000MΩ Min

Insulating Resistance: 1000 MΩ Min

耐電壓: AC 500V/分鐘

Withstanding Voltage: AC 500V/Minute

溫度範圍: -55° C to +125° C

Temperature Range: -55° C to +125° C

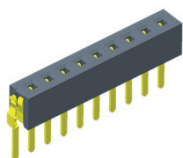

F321-11XXXXXSUX1

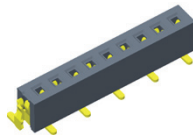

F321-11XXXXXMUX1

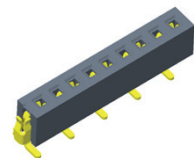

F321-11XXXXXMUX2

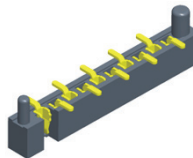

F321-11XXXXXMUX3

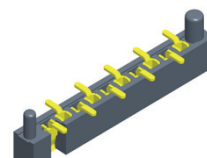

F321-11XXXXXMUX4

Mating With/ 配對公座:  
P310/P315/P316/P317/P320/P325

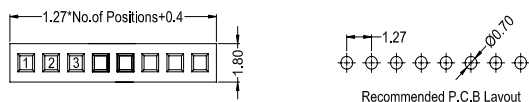
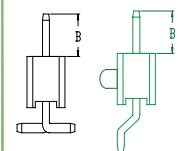
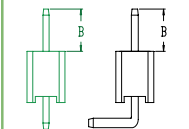

Recommended P.C.B Layout

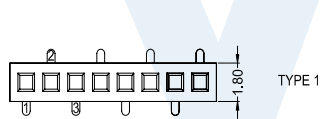
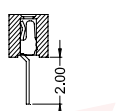
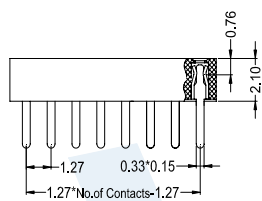

TYPE 1

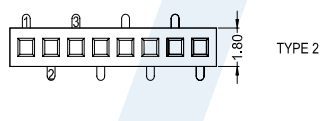
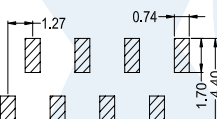

TYPE 2

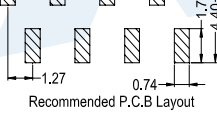

Recommended P.C.B Layout

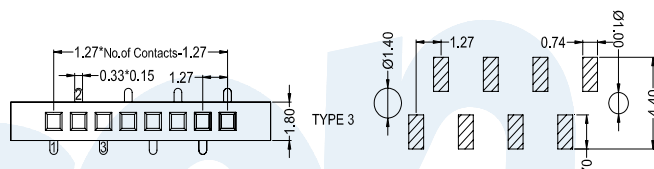
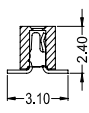
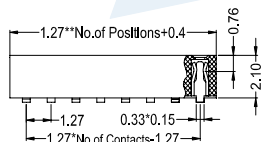

TYPE 3

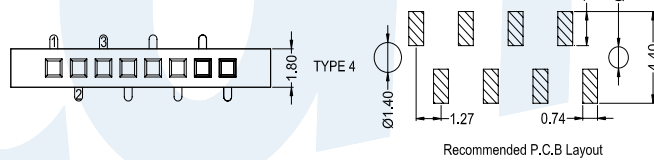

TYPE 4

Recommended P.C.B Layout

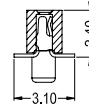
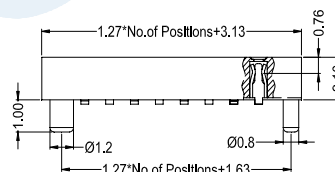

F 3 2 1 - 1 1

X X

X X

X

X

U

X

X

No.Of Pins Per Row  
02~50P

Contact Plating  
Full Of Gold A0=0.8u"  
Semi-Gold B0=0.8U"  
~  
A9=30u" B9=30U"  
S1=Ordinary Tin Plated  
S2=Matte Tin Plated  
S3=Tin-plated High-temperature

Insulator Material:  
B:PA6T  
C:PA9T  
D:LCP

Contact Shape:  
S: Straight  
M: SMT

Packing  
A: PE Bag  
B: Tape & Reel  
C: Tube  
D: Tube+CAP  
E: Tray

Journal Number  
1: Type1  
2: Type2  
3: Type3  
4: Type4

**Specifications**

備注 (Remark)

1. 材料 (Material)

膠芯: PA9T/LCP+30% G. F UL94V-0, 顏色: 黑色

Housing: PA9T/LCP+30% G. F UL94V-0,

Color: Black

端子: 磷銅

Contact: Phosphor Bronze

2. 特性 (characteristics):

額定電流: 1.0AMP

Rating Current: 1.0AMP

接觸阻抗: 20mΩ Max

Contact Resistance: 20mΩ Max

絕緣阻抗: 1000MΩ Min

Insulating Resistance: 1000 MΩ Min

耐電壓: AC 500V/分鐘

Withstanding Voltage: AC 500V/Minute

溫度範圍: -55° C to +125° C

Temperature Range: -55° C to +125° C

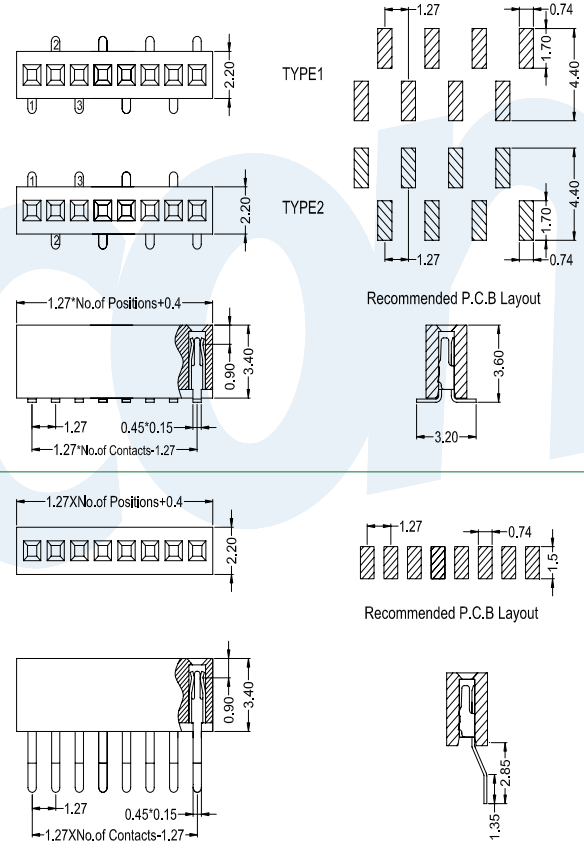
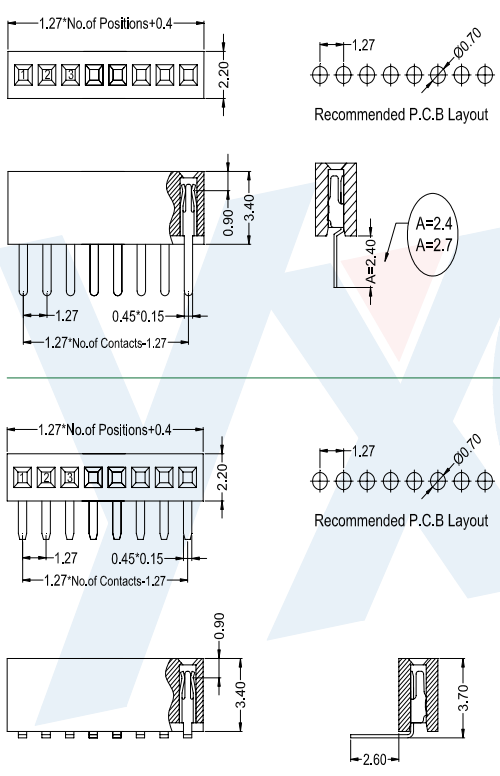
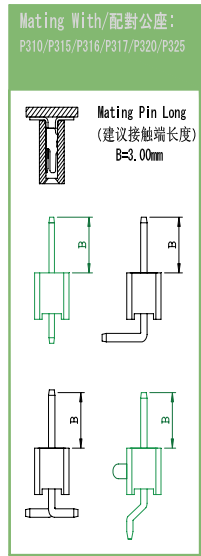
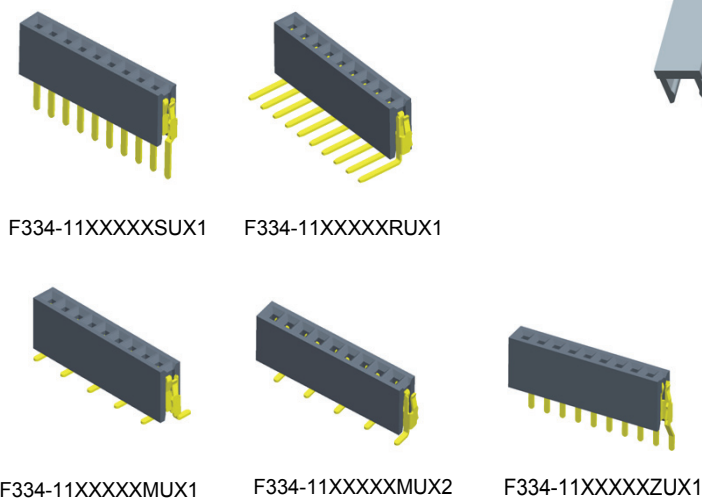

<b>F 3 3 4 - 1 1</b>	<b>XX</b>	<b>XX</b>	<b>X</b>	<b>X</b>	<b>U</b>	<b>X</b>	<b>X</b>
<b>No.Of Pins Per Row</b>	<b>Contact Plating</b>	<b>Insulator Material:</b>	<b>Contact Shape:</b>	<b>Packing</b>	<b>Journal Number</b>		
02~50P	Full Of Gold A0=0.8u" ~ A9=30u" S1=Ordinary Tin Plated S2=Matte Tin Plated S3=Tin-plated High-temperature	Semi-Gold B0=0.8U" ~ B9=30U"	S: Straight R: Right Angle M: SMT Z: 90° SMT	A: PE Bag B: Tape & Reel C: Tube D: Tube+CAP E: Tray	1: Type1 2: Type2		

**Specifications**

備注 (Remark)

1. 材料 (Material)

膠芯: PA9T/LCP+30% G.F UL94V-0, 顏色: 黑色

Housing: PA9T/LCP+30% G.F UL94V-0,

Color: Black

端子: 磷銅

Contact: Phosphor Bronze

2. 特性 (characteristics):

額定電流: 1.0AMP

Rating Current: 1.0AMP

接觸阻抗: 20mΩ Max

Contact Resistance: 20mΩ Max

絕緣阻抗: 1000MΩ Min

Insulating Resistance: 1000 MΩ Min

耐電壓: AC 500V/分鐘

Withstanding Voltage: AC 500V/Minute

溫度範圍: -55° C to +125° C

Temperture Range: -55° C to +125° C

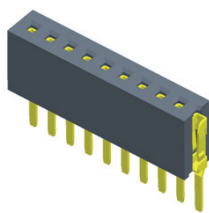

F334-11XXXXXSFX1

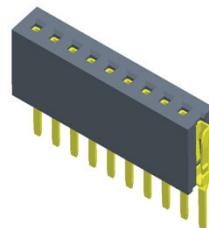

F343-11XXXXXSFX1

Mating With/配對公座:  
P310/P315/P316/P317/P320/P325

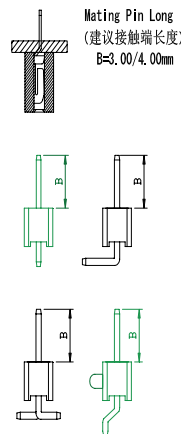

FEMALE HEADER

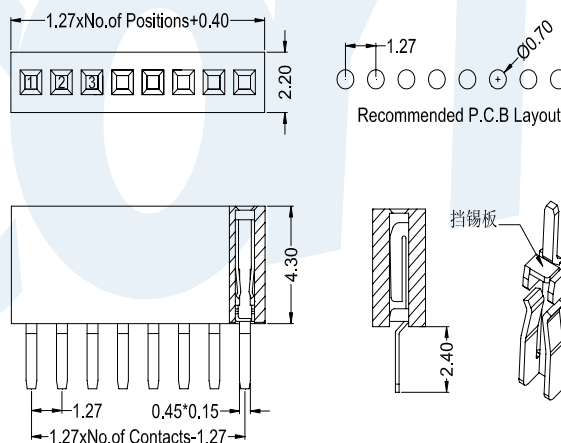
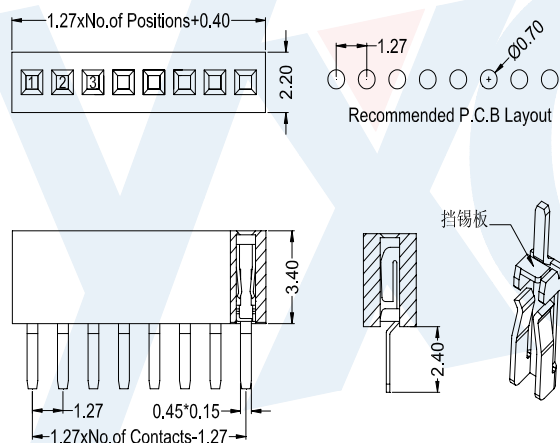

F 3 3 4 - 1 1

F 3 4 3 - 1 1

X X

No. Of Pins  
Per Row  
02~50P

X X

Contact Plating  
Full Of Gold    Semi-Gold  
A0=0.8u"    B0=0.8u"  
~    ~  
A9=30u"    B9=30u"  
S1=Ordinary Tin Plated  
S2=Matte Tin Plated  
S3=Tin-plated High-temperature

X

Insulator Material:  
B: PA6T  
C: PA9T  
D: LCP

S

F

Packing

A: PE Bag  
B: Tape & Reel  
C: Tube  
D: Tube+CAP  
E: Tray

X

1

**Specifications**

備注 (Remark)

1. 材料 (Material)

膠芯: PA9T/LCP+30% G. F UL94V-0, 顏色: 黑色

Housing: PA9T/LCP+30% G. F UL94V-0,

Color: Black

端子: 磷銅

Contact: Phosphor Bronze

2. 特性 (characteristics):

額定電流: 1.0AMP

Rating Current: 1.0AMP

接觸阻抗: 20mΩ Max

Contact Resistance: 20mΩ Max

絕緣阻抗: 1000MΩ Min

Insulating Resistance: 1000 MΩ Min

耐電壓: AC 500V/分钟

Withstanding Voltage: AC 500V/Minute

溫度範圍: -55° C to +125° C

Temperature Range: -55° C to +125° C

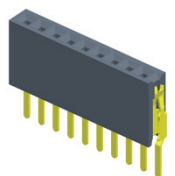

F343-11XXXXXSUX1

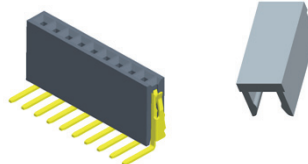

F343-11XXXXRXU1

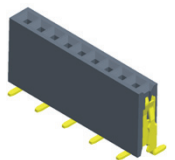

F343-11XXXXXMUX1

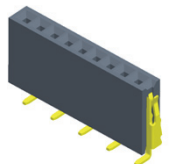

F343-11XXXXXMUX2

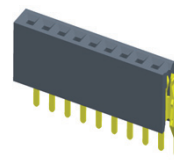

F343-11XXXXXZUX2

Mating With/配對公座:  
P310/P315/P316/P317/P320/P325

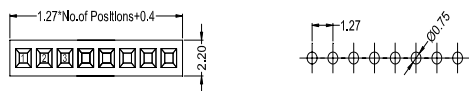
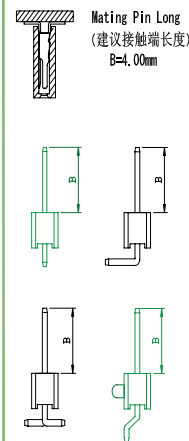

Recommended P.C.B Layout

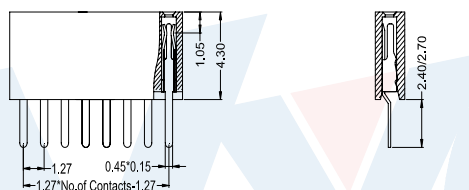

Recommended P.C.B Layout

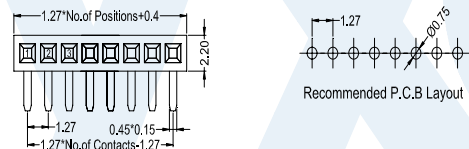

Recommended P.C.B Layout

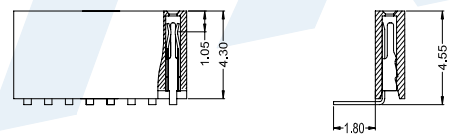

Recommended P.C.B Layout

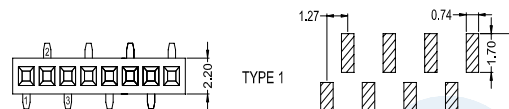

TYPE 1

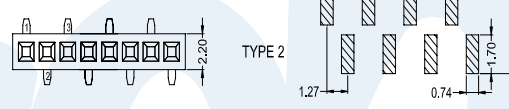

TYPE 2

Recommended P.C.B Layout

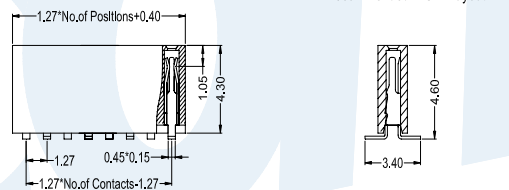

Recommended P.C.B Layout

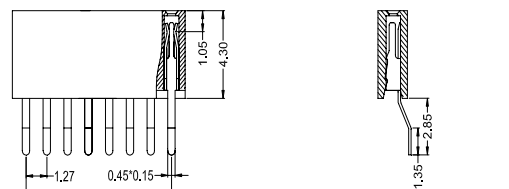

Recommended P.C.B Layout

**F 3 4 3 - 1 1**

**X X**

**X X**

**X**

**X**

**U**

**X**

**X**

**No.Of Pins Per Row**  
02~50P

**Contact Plating**

Full Of Gold A0=0.8u"  
Semi-Gold B0=0.8u"  
~  
A9=30u" B9=30u"  
S1=Ordinary Tin Plated  
S2=Matte Tin Plated  
S3=Tin-plated High-temperature

**Insulator Material:**

B:PA6T  
C:PA9T  
D:LCP

**Contact Shape:**

S: Straight  
R: Right Angle  
M: SMT  
Z: 90° SMT

**Packing**

A: PE Bag  
B: Tape & Reel  
C: Tube  
D: Tube+CAP  
E: Tray

**Journal Number**

1: Type1  
2: Type2

**Specifications**

備注 (Remark)

1. 材料 (Material)

膠芯: PA9T/LCP+30% G.F UL94V-0, 顏色: 黑色

Housing: PA9T/LCP+30% G.F UL94V-0,

Color: Black

端子: 磷銅

Contact: Phosphor Bronze

2. 特性 (characteristics):

額定電流: 1.0AMP

Rating Current: 1.0AMP

接觸阻抗: 20mΩ Max

Contact Resistance: 20mΩ Max

絕緣阻抗: 1000MΩ Min

Insulating Resistance: 1000 MΩ Min

耐電壓: AC 500V/分鐘

Withstanding Voltage: AC 500V/Minute

溫度範圍: -55° C to +125° C

Temperture Range: -55° C to +125° C

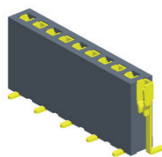

F344-11XXXXXMPX1

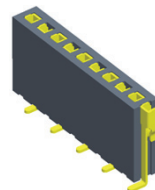

F344-11XXXXXMPX2



Mating With/配對公座:  
P310/P315/P316/P317/P320/P325

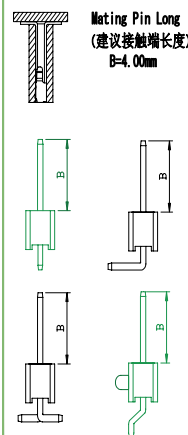

FEMALE HEADER

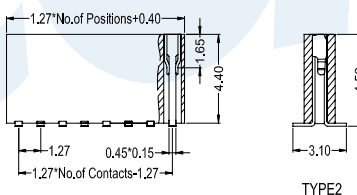
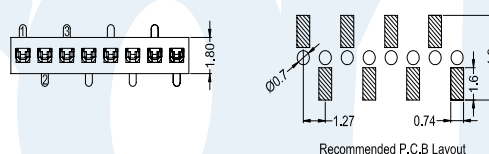
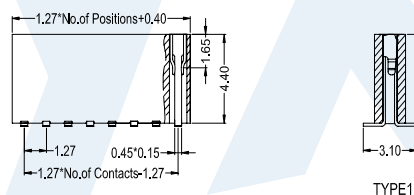
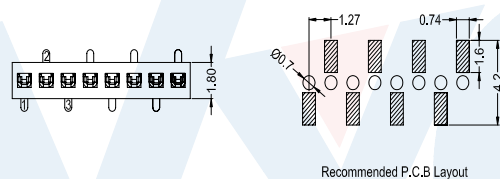

**F 3 4 4 - 1 1**

**XX**

**XX**

**X**

**M**

**P**

**X**

**X**

**No. Of Pins  
Per Row**  
02~50P

**Contact Plating**  
Full Of Gold A0=0.8u"  
Semi-Gold B0=0.8U"  
A9=30u" B9=30U"  
S1=Ordinary Tin Plated  
S2=Matte Tin Plated  
S3=Tin-plated High-temperature

**Insulator Material:**  
B: PA6T  
C: PA9T  
D: LCP

**Packing**  
A: PE Bag  
B: Tape & Reel  
C: Tube  
D: Tube+CAP  
E: Tray

**Journal Number**  
1: Type1  
2: Type2

## Specifications

備注 (Remark)

1. 材料 (Material)

膠芯: PA9T/LCP+30% G. F UL94V-0, 顏色: 黑色

Housing: PA9T/LCP+30% G. F UL94V-0,

Color: Black

端子: 磷銅

Contact: Phosphor Bronze

2. 特性 (characteristics):

額定電流: 1.0AMP

Rating Current: 1.0AMP

接觸阻抗: 20mΩ Max

Contact Resistance: 20mΩ Max

絕緣阻抗: 1000MΩ Min

Insulating Resistance: 1000 MΩ Min

耐電壓: AC 500V/分鐘

Withstanding Voltage: AC 500V/Minute

溫度範圍: -55° C to +125° C

Temperture Range: -55° C to +125° C

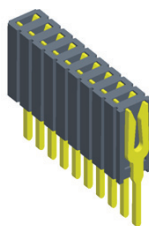

F346-11XXXXSYX3

Mating With/配對公座:  
P310/P315/P316/P317/P320/P325

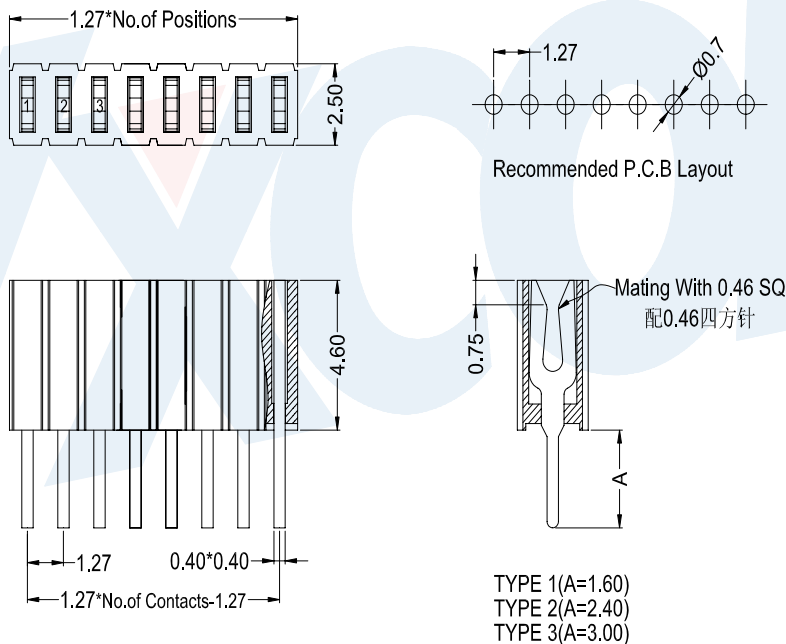
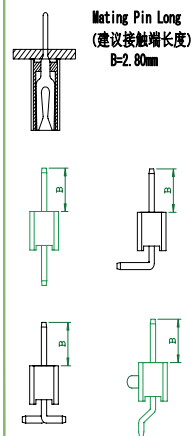

FEMALE HEADER

F 3 4 6 - 11

XX

XX

X

S

Y

X

X

No. Of Pins Per Row  
02~50P

Contact Plating  
Full Of Gold A0=0.8u"  
Semi-Gold B0=0.8U"  
~  
A9=30u" B9=30U"  
S1=Ordinary Tin Plated  
S2=Matte Tin Plated  
S3=Tin-plated High-temperature

Insulator Material:  
B: PA6T  
C: PA9T  
D: LCP

Packing  
A: PE Bag  
B: Tape & Reel  
C: Tube  
D: Tube+CAP  
E: Tray

Journal Number  
1: Type1  
2: Type2  
3: Type3

Http://www.yxcon.com

E-mail:yx@yxcon.com

YUXI DONGGUAN (東莞)  
YUXI TAIWAN (台灣)

TEL:+86 769 85397456  
TEL:+886 3313 2933

FAX:+86 769 85396015  
FAX:+886 3313 2935

**Specifications**

備注 (Remark)

1. 材料 (Material)

膠芯: PA9T/LCP+30% G.F UL94V-0, 顏色: 黑色

Housing: PA9T/LCP+30% G.F UL94V-0,

Color: Black

端子: 磷銅

Contact: Phosphor Bronze

2. 特性 (characteristics):

額定電流: 1.0AMP

Rating Current: 1.0AMP

接觸阻抗: 20mΩ Max

Contact Resistance: 20mΩ Max

絕緣阻抗: 1000MΩ Min

Insulating Resistance: 1000 MΩ Min

耐電壓: AC 500V/分鐘

Withstanding Voltage: AC 500V/Minute

溫度範圍: -55° C to +125° C

Temperture Range: -55° C to +125° C

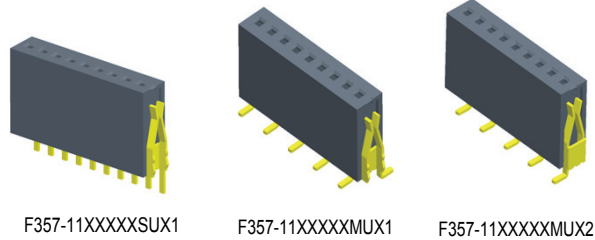

F357-11XXXXXSUX1

F357-11XXXXXMUX1

F357-11XXXXXMUX2

Mating With/配對公座:  
P310/P315/P316/P317/P320/P325

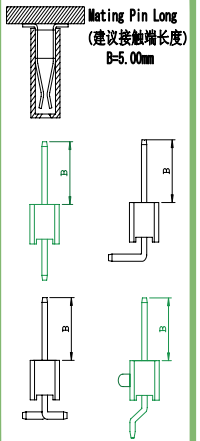

FEMALE HEADER

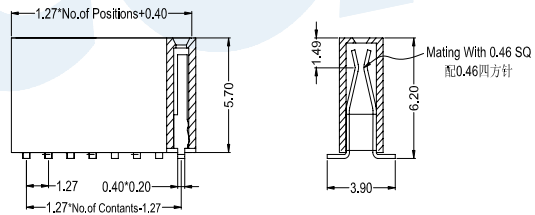
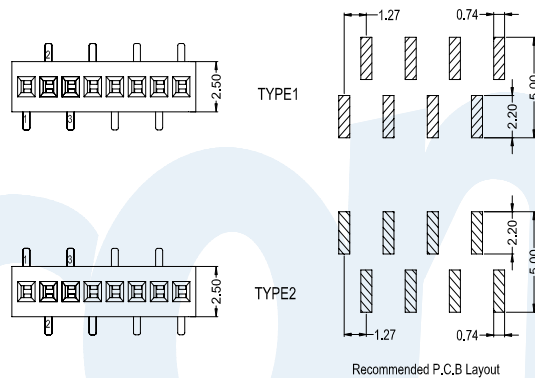
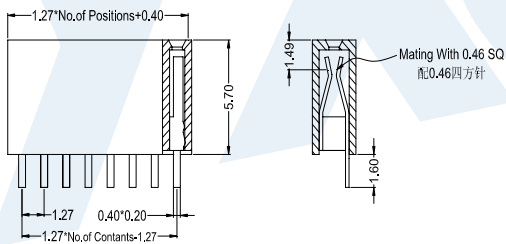
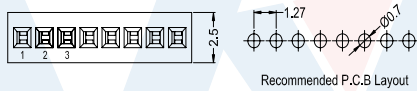

<b>F 3 5 7 - 1 1</b>	<b>XX</b>	<b>XX</b>	<b>X</b>	<b>X</b>	<b>U</b>	<b>X</b>	<b>X</b>
<b>No.Of Pins Per Row</b> 02~50P	<b>Contact Plating</b> Full Of Gold A0=0.8u" Semi-Gold B0=0.8u" ~ A9=30u" B9=30U" S1=Ordinary Tin Plated S2=Matte Tin Plated S3=Tin-plated High-temperature	<b>Insulator Material:</b> B:PA6T C:PA9T D:LCP	<b>Contact Shape:</b> S: Straight M: SMT	<b>Packing</b> A: PE Bag B: Tape & Reel C: Tube D: Tube+CAP E: Tray	<b>Journal Number</b> 1: Type1 2: Type2		

Http://www.yxcon.com E-mail:yx@yxcon.com

YUXI DONGGUAN (東莞) TEL:+86 769 85397456 FAX:+86 769 85396015  
 YUXI TAIWAN (台灣) TEL:+886 3313 2933 FAX:+886 3313 2935



**Specifications**

備注 (Remark)

1. 材料 (Material)

膠芯: PA9T/LCP+30% G. F UL94V-0, 顏色: 黑色

Housing: PA9T/LCP+30% G. F UL94V-0,

Color: Black

端子: 磷銅

Contact: Phosphor Bronze

2. 特性 (characteristics):

額定電流: 1.0AMP

Rating Current: 1.0AMP

接觸阻抗: 20mΩ Max

Contact Resistance: 20mΩ Max

絕緣阻抗: 1000MΩ Min

Insulating Resistance: 1000 MΩ Min

耐電壓: AC 500V/分鐘

Withstanding Voltage: AC 500V/Minute

溫度範圍: -55° C to +125° C

Temperture Range: -55° C to +125° C

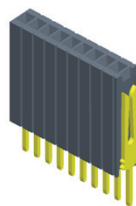

F385-11XXXXXXSYX1

Mating With/配對公座:  
P310/P315/P316/P317/P320/P325

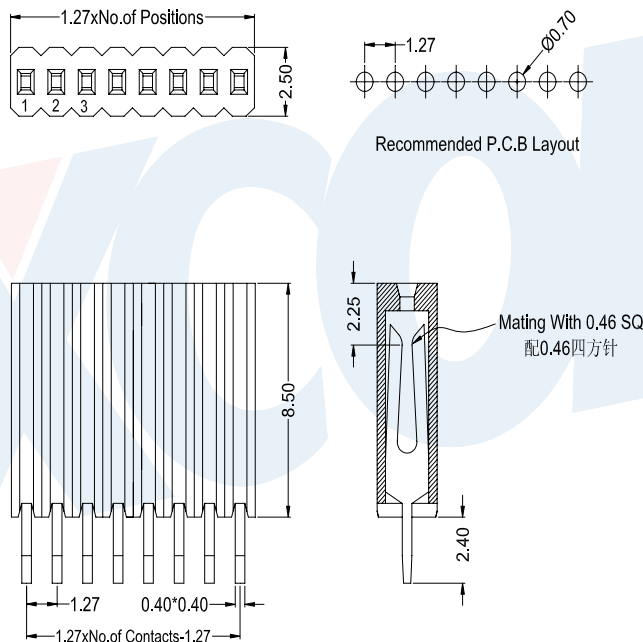
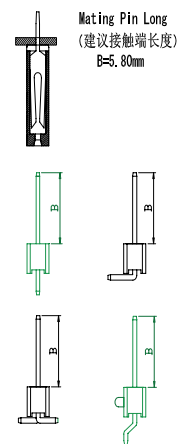

FEMALE HEADER

F 3 8 5 - 1 1

X X

X X

X

S

Y

X

1

**No.Of Pins Per Row**  
02~50P

**Contact Plating**  
Full Of Gold A0=0.8u"  
Semi-Gold B0=0.8U"  
~  
A9=30u" B9=30U"

**Insulator Material:**  
B:PA6T  
C:PA9T  
D:LCP

**Packing**  
A:PE Bag  
B:Tape & Reel  
C:Tube  
D:Tube+CAP  
E:Tray

S1=Ordinary Tin Plated  
S2=Matte Tin Plated  
S3=Tin-plated High-temperature

Http://www.yxcon.com

E-mail:yx@yxcon.com

YUXI DONGGUAN (東莞)  
YUXI TAIWAN (台灣)

TEL:+86 769 85397456  
TEL:+886 3313 2933

FAX:+86 769 85396015  
FAX:+886 3313 2935