

Specifications

备注 (Remark)
 1. 材料 (MATERIAL)
 胶芯: PA6T/PBT+30%G.F UL94V-0, 颜色: 黑色.
 Housing: PA6T/PBT+30%G.F UL94V-0, Color: Black
 四方针: 黄铜, 镍底30u"MIN, 表面镀金0.8u"MIN
 Contact: Brass, 0.8u"MIN GOLD PLATING OVER ALL
 30u" MIN NICKEL UNDERPLATING OVER ALL

2. 特性 (characteristics):
 额定电流: 3 AMP
 Rating Current: 3 AMP.
 接触阻抗: 20 mΩ MAX.
 Contact Resistance: 20 mΩ MAX.
 绝缘阻抗: 1000 MΩ MIN.
 Insulating Resistance: 1000 MΩ MIN.
 耐电压: AC 500V.
 Withstanding Voltage: AC 500V.
 温度范围: -40°C to+105°C
 Temperature Range: -40°C to+105°C

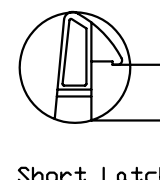
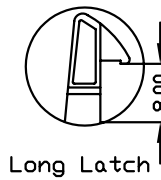
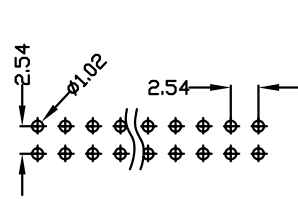

Ordering Information

E10X-1 XX XX X R X X 1

1.LONG-EARED 2.SHORT-EARED	NO.OF PINS 6-64P	Contact Plating Full Of Gold A0=0.8u" A1=1u" A2=1.5u" A3=2u" A4=3u" A5=5u" A6=10u" A7=15u" A8=20u" A9=30u" S1=Ordinary Tin Plated S2=Matte Tin Plated S3=Tin-plated High-temperature	Semi-gold B0=0.8u" B1=1u" B2=1.5u" B3=2u" B4=3u" B5=5u" B6=10u" B7=15u" B8=20u" B9=30u"	INSULATOR MATERIAL: A:PBT B:PA6T C:PA9T D:LCP	B:Black G:Grey427 E:Grey413 W:White U:Blue	PACKING A:PE Bag B:Tape & Reel C:Tube D:Tube+CAP E:Tray
-------------------------------	---------------------	--	---	---	--	--

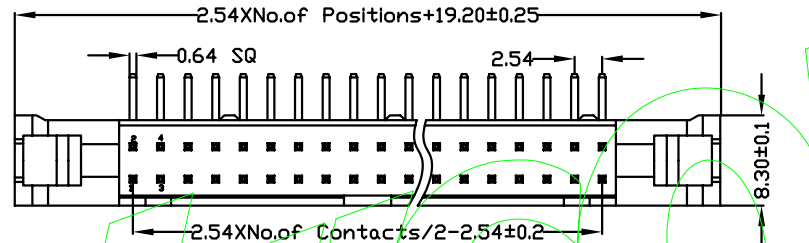

(60.64PIN)三个
缺口, 两个窗口

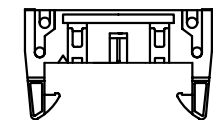

(20.24.26.30
34.40.50PIN)
一个缺口, 两个窗
口

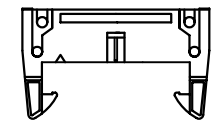

(10 14 16PIN)一
个缺口

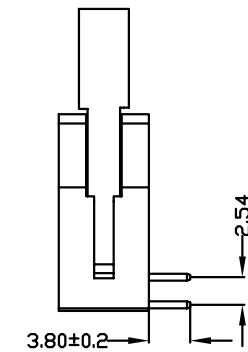
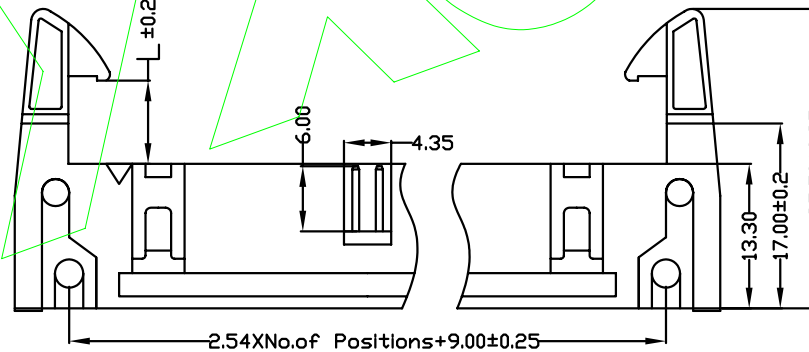

NAME	PART NO
Long Latch	E101-1XXXXXXRX1
Short Latch	E102-1XXXXXXRX1

REV	DATE	MODIFICATION DESCRIPTION	CHANGE	APPROVE	OPERATION		SCALE		Fit	Yxcon 东莞市宇熙精密连接器有限公司 Dongguan Yuxi Electronic Co.,Ltd.	PART NO.	E10X-1XXXXXXRX1
					DIM	TOL	PROJ.	UNIT	MM			
					X.X	±0.25	SIZE	A4	DESIGN	卢小强		
					X.XX	±0.20	SHEET	1/1	CHECK		TITLE:	2.54mm 牛角 90度
					X.XXX	±0.10	APPROVE				Customer No.	
					Angle	±3°						